

## Chapter

# CMOS Active Inductor and Its Applications

*Dhara Pinkesh Patel*

## Abstract

Electronic industries always drive to add more functionalities to the devices. Tunability and compactness have become thrust parameters for the microelectronic researchers. In wireless communication, capacitor and inductor are the most significant reactive components for frequency selection. Out of these two reactive components, inductor occupies significant size of entire chip area. As a result, any circuit containing passive inductor such as voltage-controlled oscillator (VCO), low-noise amplifier (LNA), filter, and power dividers consume wider chip size. To meet the requirement of microelectronics industries, passive components have been replaced with active ones. In this chapter, passive inductor has been substituted with CMOS based active inductor.

**Keywords:** active inductor (AI), compact, gyrator, tunability, trans conductance

## 1. Passive Inductor

A passive spiral inductor is an electrical component comprising of coil or wire which is associated with the magnetism and electricity as current passes through the coil. It stores electrical energy in the form of magnetic field. The current passing through the inductor lags inductor voltage by  $90^\circ$  **Figure 1** shows the signal flow diagram of passive inductor.

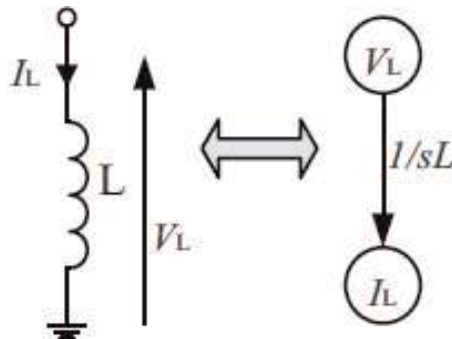

**Figure 1.**  
*An ideal spiral inductor and signal flow graph representation.*

Current flowing through the ideal inductor as shown in **Figure 1** can be described by the following equation:

$$I_{in} = \left( \frac{1}{sL} \right) V_{in} \quad (1)$$

$$Z_{in} = \frac{V_{in}}{I_{in}} = sL \quad (2)$$

## 2. Active inductor

The design of tunable and compact RF-integrated circuit is challenging. Although spiral inductor is the common implementation approach in integrated circuits, it is possible to design active circuits [1–5]. As reported in [6], active inductor occupies 1–5% of the passive inductor, and the most unique feature is its tunability of inductance. Further, **Table 1** demonstrates the basic comparison between active and passive inductors.

### 2.1 Active inductor design methods

Integrated circuits can be designed for specific frequency bands. Design of active inductors is possible for required operating frequency bands. There are two elementary approaches to configure the active inductors.

1. Operational amplifier-based approach
2. Gyrator-C-based approach

The former one is based on operational amplifier (op-Amp), and it is widely used at moderate frequencies (up to about 100 MHz). The later one is gyrator-C based, which can be operated from sub-gigahertz to gigahertz frequency range. Apart from that, op-amp-based active inductor circuit occupies large chip area and suffers from nonlinearity. As a counterpart, gyrator-based active inductor consumes small chip area and shows better linearity [6]. In present work, to design active inductor at sub GHz, gyrator-C-based active inductor approach has been considered.

| Parameters                         | Passive inductor         | Active inductor    |
|------------------------------------|--------------------------|--------------------|
| Area                               | Large die area           | Small die area     |
| Tunability                         | Fixed                    | Large tuning range |
| Q factor                           | Low                      | High               |
| Power consumption                  | Zero                     | Significant        |
| Noise performance                  | superior                 | Poor               |
| Linearity                          | Good                     | Poor               |
| Electromagnetic Interference (EMI) | Significant EMI problems | EMI insensitive    |

**Table 1.** Comparison between active and passive inductors.

### 3. Gyrator

In 1948, scientist of Philips Research Laboratory, Bernard D.H. Tellegen, proposed a new two-port fundamental circuit element. An ideal gyrator is a linear two-port device that couples the current on one port to the voltage on the other port and vice versa. as shown in **Figure 2**:

$$i_1 = Gv_2 \quad (3)$$

$$i_2 = -Gv_1 \quad (4)$$

where  $G$  presents the gyration conductance.

The gyration conductance ( $G$ ) relates the voltage on the port 2 ( $v_2$ ) to the current in port 1 ( $i_1$ ). The voltage on port 1 ( $v_1$ ) is associated with current in port 2 ( $i_2$ ), as minus shows the direction of conductance. It proves that gyrator is a nonreciprocal device. From the gyration conductance, it is called as gyrator [7].

From Eqs. (3) and (4), the ideal gyrator is described by the conductance matrix as shown below,

$$\begin{bmatrix} i_1 \\ i_2 \end{bmatrix} = \begin{bmatrix} \mathbf{0} & G \\ -G & \mathbf{0} \end{bmatrix} \begin{bmatrix} v_1 \\ v_2 \end{bmatrix}$$

The impedance matrix is defined by:

$$[Z] = \begin{bmatrix} \mathbf{0} & R \\ -R & \mathbf{0} \end{bmatrix}$$

The admittance matrix is expressed by:

$$[Y] = \begin{bmatrix} \mathbf{0} & G \\ -G & \mathbf{0} \end{bmatrix}$$

A generalization of the gyrator is conceivable, in which the forward and backward gyration conductances have different magnitudes, so that the equivalent equations can be written as follows:

$$\begin{bmatrix} i_1 \\ i_2 \end{bmatrix} = \begin{bmatrix} \mathbf{0} & G_{m1} \\ -G_{m2} & \mathbf{0} \end{bmatrix} \begin{bmatrix} v_1 \\ v_2 \end{bmatrix}$$

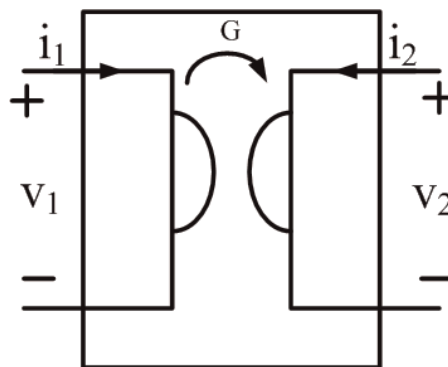

**Figure 2.**  
 Ideal gyrator.

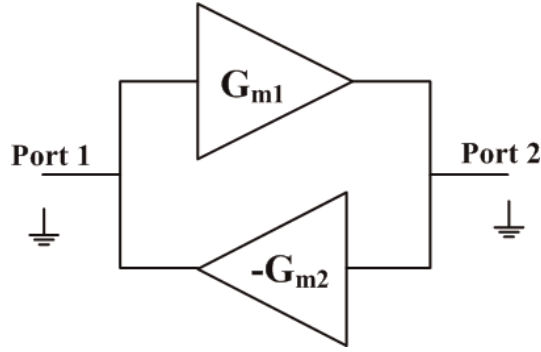

**Figure 3.**  
Ideal gyrator.

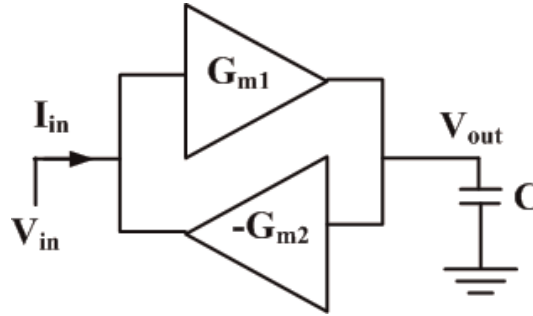

**Figure 4.**  
Ideal gyrator-C based active inductor.

The above matrix can be resulted into block diagram as illustrated in **Figure 3**. It tells that gyrator comprises of two transconductors: positive transconductor  $G_{m1}$  and negative transconductor  $G_{m2}$ , connected in a closed loop as shown in **Figure 4**. The transconductor-1 shows positive transconductance means output current and input voltage are in phase. Whereas, transconductor-2 depicts negative transconductance means output current and input voltage are  $180^\circ$  phase shifted (**Figure 3**).

Tellegen noticed that when a capacitor is connected to the secondary terminal (port 2), an inductance is realized at the primary terminal (port 1) of the gyrator, which is entitled as gyrator-C topology as presented in **Figure 4**.

#### 4. Gyrator-C-based active inductor and its working principle

By comparing Eq. (5) with Eq. (2), it clearly tells us that input impedance  $Z_{in}$  is directly proportional to frequency, and the impedance seen at port 2 is inductive. This is an important property of the gyrator, which shows equivalent inductor. Subsequently, equivalent inductance can be defined as,

$$Z_{in} = \frac{V_{in}}{I_{in}} = \frac{sC}{G_{m1}G_{m2}} \quad (5)$$

$$L = \frac{C}{G_{m1}G_{m2}} \quad (6)$$

Therefore, gyrator-C network is used to synthesize active inductor. This synthesized inductor is called as gyrator-C active inductor. The inductance of active

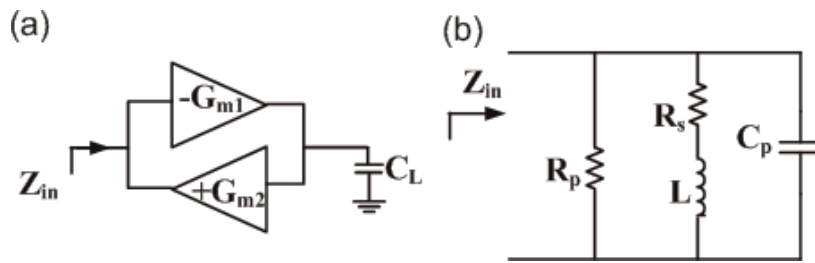

**Figure 5.** Practical gyrator-C-based inductor (a) block diagram, (b) equivalent circuit diagram.

inductor is proportional to the load capacitance  $C$  and inversely proportional to the product of the transconductances of the transconductors.

In practical active inductor circuit, along with the inductance, we do get parasitic components as series resistance  $R_s$ , parallel resistance  $R_p$  and parallel capacitance  $C_p$ . These parasitic RC components ultimately affecting on the performance of active inductor (Figure 5).

## 5. Performance parameters of active inductors

In order to define the active inductor circuit, few parameters need to be measured. In this section, we shall discuss about the several active inductor parameters such as inductive range, tunability, quality factor, power consumption, linearity, supply voltage sensitivity and noise. These analyses can be understood when we go through the ac analysis, noise analysis, transient analysis and harmonic analysis.

### 5.1 Inductive tuning range

An ideal gyrator-C-based active inductor shows inductive behaviour over the entire frequency range. But a lossy active inductor exhibits resistive, inductive and capacitive frequency range. The respective range can be analysed by analysing the impedance of equivalent RLC circuit of active inductor. In order to acquire the relation between frequency and magnitude, bode plot has been used. Further to accomplish the bode plot of frequency versus impedance magnitude, 1 A sinusoidal ac current is applied at input port. As a result, the voltage measurement at the same input port results into input impedance. Below mentioned steps are required to derive the tuning inductive range.

1. To derive the inductive band frequency for active inductor, we need to draw the small signal model of the circuit. After that application of Kirchoff's voltage or current law helps to simplify the circuit. The input impedance of equivalent circuit of practical active inductor can be written as shown in Eq. (1).

$$Z_{in} = \left( \frac{R_s}{C_p L} \right) \frac{s \frac{L}{R_s + 1}}{s^2 + s \left( \frac{1}{R_p C_p} + \frac{R_s}{L} \right) + \frac{R_s + R_p}{R_p C_p L}} \quad (7)$$

1. The inductive pole frequency of  $Z_{in}$  is given by

$$\omega_p = \sqrt{\frac{R_p + R_s}{R_p C_p L}} \quad (8)$$

Because  $R_p \gg R_s$ , it is simplified as,

$$\omega_p \approx \sqrt{\frac{1}{LC_p}} = \omega_0 \quad (9)$$

where  $\omega_0$  is the maximum inductive frequency of the active inductor. Above Eq. (8) tells us that the higher value of inductance and parallel capacitance enhance the value of resonance frequency.

1. The zero frequency can be written as,

$$\omega_z = \frac{R_s}{L} \quad (10)$$

Eq. (10) mentions that zero frequency is proportional to series resistance and inversely proportional to inductance.

1. From the zero and pole frequency, the inductive frequency range can be defined as,

$$\omega_z = \frac{R_s}{L} \leq \omega \leq \frac{1}{\sqrt{LC_p}} = \omega_0 \quad (11)$$

Eq. (11) clearly depicts that  $R_s$  affects the lower range of the inductive frequency range, whereas the upper range of inductive frequency can be set by maximum inductive frequency of the active inductor. In order to achieve maximum inductive range, both the  $R_s$  and  $C_p$  should be minimum at given inductance L.

1. To verify the inductive behaviour, the phase response is equally important. The entire inductive range impedance phase should be  $90^\circ$ . In other words, voltage should lead the current by  $90^\circ$ .

Higher number of transistors in gyrator active inductor generates the parasitic poles, which increases the phase shift of transistors and reduces the inductive tuning range [7].

To observe the inductive behaviour through the bode plot, we can apply 1 V ac current to the input node and observe the voltage at output node. Subsequently, frequency response gives the frequency versus impedance magnitude plot, and the phase plot can give the frequency versus phase. **Figure 6** shows the bode plot response on Cadence Spectre Spice tool. The inductive frequency can be defined at which the phase is  $90^\circ$ .

## 5.2 Inductance tunability

The active inductor can be tuned by two different ways:

1. Variation in the transconductance of the transconductors
2. Variation in the load capacitance (**Figure 7**)

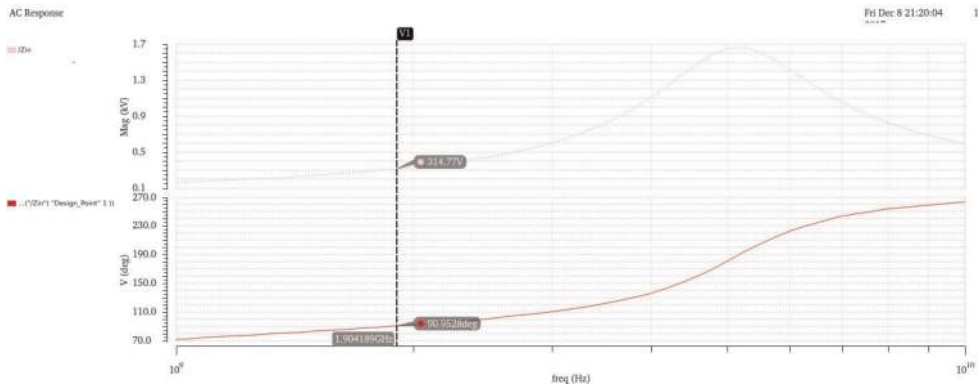

**Figure 6.**  
 Bode plot of CMOS active inductor [1].

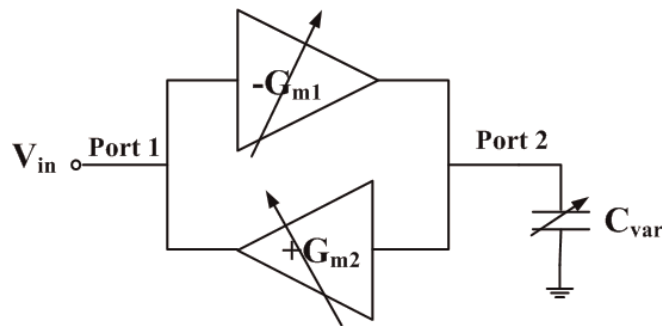

**Figure 7.**  
 Tuning in gyrator-C network.

### 5.3 Quality factor

Spiral inductor contains a small coil resistance in addition to inductance, and hence, it has quite low quality factor. The quality of inductance in coil is defined by quality factor. It is defined as the ratio of reactance of the coil to its series resistance.

$$Q = \frac{X_L}{R} \quad (12)$$

For CMOS active inductor, once the input impedance is derived, then quality factor can be defined as,

$$Q = \frac{Im(Z_{in})}{Re(Z_{in})} \quad (13)$$

From Eqs. (7) and (13), quality factor of active inductor can be represented as,

$$Q = \left( \frac{\omega L}{R_s} \right) \frac{R_p}{R_p + R_s \left[ 1 + \left( \frac{\omega L}{R_s} \right)^2 \right]} \left[ 1 - \frac{R_s^2 C_p}{L} - \omega^2 L C_p \right] \quad (14)$$

The higher value of quality factor shows the low loss in active inductor. It is a crucial parameter to design active inductor. The higher and sustainable quality factor over the entire inductive frequency range is the challenge for analog-integrated circuit designers. In depicted paper [1], Widlar current source has been used to enhance the quality factor of inductor and in [2], it has been used in voltage-controlled oscillator.

## 5.4 Noise

As active inductor is made up of active components, it suffers from the internal noise. The main noises can be listed as thermal noise, flicker noise and noise due to the distributed substrate used in transistors. Through the equivalent noise model of active inductor circuit, we can analyze it clearly.

## 5.5 Linearity

For ideal active inductor, all the transistors of circuit must be in saturation region over the entire inductive tuning range. But, in practical active inductor circuit, few transistors switch over from saturation to triode region. The transconductance of transistor varies from saturation to triode region. As a result, the inductance value also gets changed, which adds nonlinearity in the active inductor working. Active inductor linearity can be characterized by two different ways, total harmonic distortion (THD) and 1 dB inductance compression  $L_{-1dB}$ . THD exhibits the ratio of total unwanted harmonic current to fundamental current when a fundamental ac input signal has been injected into the active inductor.  $L_{-1dB}$  can be defined as the input current amplitude has become 1 dB large than its small signal value.

## 5.6 Power consumption

Active components in active inductor consume static power. Less number of transistors in submicron CMOS technology and circuit configuration without body effect are generally used methods to reduce power consumption in active inductor.

## 5.7 Supply voltage sensitivity

The fluctuations in DC supply voltage of active inductor also affect the performance of active inductor.

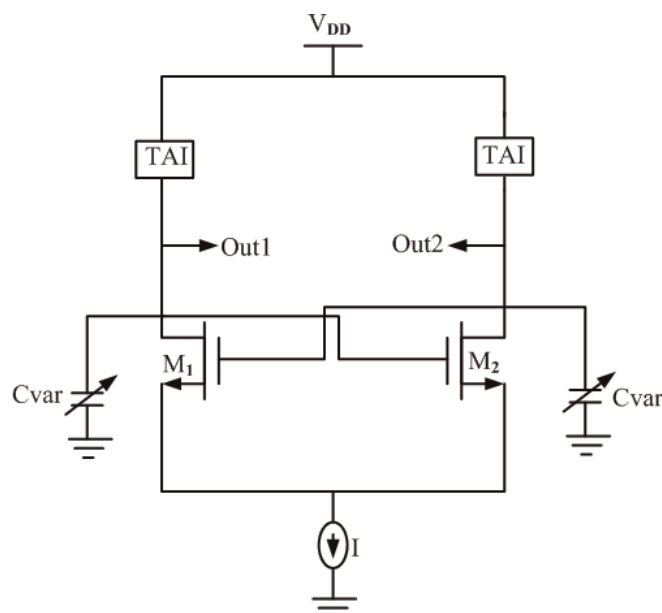

**Figure 8.**  
Tunable voltage-controlled oscillator.





Generally, voltage-controlled oscillator is tuned using varactor capacitor where the tuning range is limited. Using tunable active inductor, we get more freedom to tune it over wider frequency range. Subsequently, we can operate more standards using a single VCO. Furthermore, it consumes less chip area.

## **6.2 Active inductor-based filter**

In [8], a second-order RF bandpass filter based on active inductor has been implemented in a 0.35  $\mu\text{m}$  CMOS process. The operating frequency of the active filter is 900 MHz with the quality factor of 40 (**Figure 9**).

## **6.3 Active inductor-based low noise amplifier**

In [9], low noise amplifier has been designed using active inductor at the ISM frequency of 2.4 GHz (**Figure 10**).

## **7. Conclusions**

The designing of active and tunable electronic components is the emerging field of today's microelectronics industry. To facilitate the compact and efficient chips, we must have to use them in our applications like voltage-controlled oscillator, filter and low noise amplifier. Apart from these, inductor has been used in matching circuits, power combiners and power dividers. Moreover, it can be used in input circuits to control the loading effects. In all these applications, passive inductor has been replaced with active inductor, where we can benefit in compactness and tenability. The more other parameters are discussed in chapter.

## **Conflict of interest**

The author has no conflict of interest to declare.

## **Notes/thanks/other declarations**

I hereby declare that this chapter on "CMOS Active Inductor and Its Applications" was carried out by me for the book publication on "Electromagnetic Devices and Machines."

## Author details

Dhara Pinkesh Patel

V.T. Patel Department of Electronics and Communication Engineering, Faculty of Technology and Engineering, Chandubhai S. Patel Institute of Technology, Charotar University of Science and Technology, Gujarat

\*Address all correspondence to: [धारapatel.ec@charusat.ac.in](mailto:धारapatel.ec@charusat.ac.in)

## IntechOpen

---

© 2019 The Author(s). Licensee IntechOpen. This chapter is distributed under the terms of the Creative Commons Attribution License (<http://creativecommons.org/licenses/by/3.0>), which permits unrestricted use, distribution, and reproduction in any medium, provided the original work is properly cited. 

## **References**

- [1] Patel DP, Oza-Rahurkar S. Tunable CMOS active inductor using widlar current source. *Journal of Circuits, Systems and Computers*. 2019;**28**(2): 1950027. DOI: 10.1142/S0218126619500270
- [2] Patel DP, Oza-Rahurkar S. CMOS active inductor/resonator based voltage controlled oscillator. *Recent Advances in Electrical and Electronic Engineering*. 2019;**12**(1). DOI: 10.2174/2352096511666181105111852
- [3] Patel DP, Oza-Rahurkar S. CMOS active inductor: A technical review. *International Journal of Applied Engineering Research*. 2018;**13**(11): 9680-9685. ISSN 0973-4562
- [4] Razavi B. *Design of CMOS Integrated Circuits*. California, USA: McGraw Hill; 2001. ISBN: 0-07-238032-2
- [5] Yuan F. *CMOS Active Inductors and Transformers*. 1st ed. Ontario, Canada: Springer; 2008. ISBN: 978-0-387-76477-1
- [6] Tellegen BDH. Passive Four Terminal Network for Gyration of a Current into a Voltage. Google Patents 2,647,239. 1953. Available from: <https://patents.google.com/patent/US2647239>
- [7] Xiao H, Schaumann B. High Frequency Active Inductor. US Patent 7,042,317 B2. 2006. Available from: <https://patents.google.com/patent/US7042317B2/en>
- [8] William B. Kuhn. Dynamic range performance of on-chip rf bandpass filters. *IEEE Transactions on circuits and systems–II: Analog and digital signal processing*. October 2003;**50**(10)
- [9] Arif Sobhan Bhuiyan M. Design of an active inductor based LNA in 130 nm CMOS process technology. *Journal of Microelectronics*. 2015;**45**(3):188-194