The Effect of Injection Timing on the Environmental Performances of the Engine Fueled by LPG in the Liquid Phase

Artur Jaworski, Hubert Kuszewski, Kazimierz Lejda and Adam Ustrzycki

Additional information is available at the end of the chapter

<http://dx.doi.org/10.5772/54604>

1. Introduction

Gaseous fuels are widely used in internal combustion engines because of their properties and benefits. This is mainly due to their smaller burden on the environment and lower prices. They are used not only to power the traction engine in passenger cars or buses, but also in other applications, for example, to power the engines driven electric generators. Ever-expanding chain of filling stations increases the availability of these fuels, which also affects the development of such fuelling systems. Because of their advantages fuel injection systems with their own drivers are used increasingly. It provides a non-collision work of mentioned drivers with a gasoline engine drivers of the vehicles, providing the performance of an engine running on gas fuel comparable to one running on gasoline.

The use of LPG injection in the liquid phase makes it possible to have more precise fuel delivery, and even more limits amount of pollution emitted by the engine to the environment. The fuelling for internal combustion engines with LPG in liquid phase using injection system into the intake manifold is a solution very similar to conventional fuel systems (Hyun et al., 2002; Lee et al., 2003). This kind of fuelling to the cylinders allows to obtain performances of engine comparable to the performances obtained using petrol and diesel fuel system.

2. Adaptation of engine to fuelling with lpg in liquid phase at sequence injection

The gas fuel system allowed the gas injection in the liquid phase was adapted to the engine, which in the original version was a compression ignition engine with symbol MD-111. This engine is a 6-cylinder Diesel engine with direct injection. The combustion chamber is made in the piston bowl and has a toroidal shape. By reducing the compression ratio and ignition

system implementation, in the first stage, the engine to gas fuelling in the volatile phase has been adapted. The combustion chamber has been redesigned, gaining “cup” shape, whereby the compression ratio was also reduced from 16.5 to 9. The cylinder head was changed enabling to implementation a spark plug. To control the engine load, in the inlet system the throttle valve was installed.

The construction and operational parameters of modernized engine are summarized in Table 1. Next, the engine was further modernized in order to adapt gas fuel system enabling to sequence injection in the liquid phase.

As a gas system, the Vialle system was used (Fig. 1). The installation consists of:

- Electronic Control Unit (ECU) of LPG fuel system,
- tank with fuel pump,
- LPG injectors,
- fuel pipes.

The system was developed for mating with the ECU of petrol engine in the system MASTER-SLAVE. In this system, ECU of LPG fuel system uses injection duration determined by ECU of petrol engine for calculating the opening duration of gas injectors. Since the MD-111E engine did not have the electronic control unit, the primary issue was to develop a control unit, generating suitable values of the injection duration for the ECU of LPG fuel system.

The main components of a LPG, i.e. propane and butane, have low boiling points. These temperatures are respectively 231 K and 272.5 K, and are lower than the average ambient temperatures encountered during engine operation. Especially high temperatures are in the engine compartment of the vehicle (hot zone), where temperatures reach about 350 K. This causes the temperature rise in the fuel system, which leads to evaporation of fuel in the fuel pipes and formation of vapour-locks (Cipollone & Villante, 2000, 2001; Dutczak et al., 2003). Keeping gas in the liquid phase in such difficult conditions requires its compression. To obtain a stable injection of LPG in the liquid phase, the system was equipped with a pressure monitoring system. This function is performed by the pump (Fig. 2) placed in the fuel tank (Fig. 3) and pressure regulator (Fig. 4). The pressure regulator maintains the pressure in the supply system higher than the pressure in the tank. It allows to delivery fuel to injectors in liquid phase at every conditions of engine operation.

The liquid gas is pumped through a suitably shaped diaphragm pump. The pump has 5 chambers, which are integrated with the suction valves and power valve. The pump motor is a brushless alternating-current motor with permanent magnets. It is powered by DC, which is transformed into AC with a frequency controlled by an electronic control unit located in the assembly lid. The motor can be rotated with five different speeds 500, 1000, 1500, 2000, 2800 rpm. Speed control is realized by the ECU of LPG fuel system, depending on engine speed and load (injection duration). The pressure regulator is located between tank and gas injectors.

No.	Name	Value
1	Producer	WS Mielec
2	Trademark	MD-111E
3	Company name	„PZL Mielec“
4	Type	MD-111E
5	Work cycle	4-stroke
6	Cylinder diameter	127 mm
7	Piston stroke	146 mm
8	Engine capacity	11097 cm ³
9	Number and basic engine design	6-cylinder, in-line
10	Firing order	1-5-3-6-2-4
11	Type of combustion system	spark ignition
12	LPG fuel system	mixer, electronic control of injection process
13	Compression ratio	9 : 1
14	Minimum cross section area: - inlet port - exhaust port	1250 mm ² 950 mm ²
15	Cooling system	liquid
16	Type of cooling liquid	Ethylene/Propylene Glycol Heat-Transfer Fluid
17	Cooling pump	impeller
18	Radiator and fan	pipe cooler, downcast ventilator with viscose clutch (EATON type)
19	Maximum outlet temperature at radiator	95°C
20	Inlet and fuel system	maximum limit of negative pressure inside inlet manifold at reference point 4.5 kPa
21	Supercharging system	not installed
22	Mixer fuel system: reducer-evaporator mixer type gas dosing system	Tartarini GP-150 MS-1 WS-Mielec electronic actuator in closed system with oxygen sensor
23	Cold start unit	Direct starting with electrical starter motor powered by battery, power 4.4 kW, voltage 24 V, type R 22
24	Maximum lift of valves	13,3 mm

No.	Name	Value
25	Inlet valve timing: - opening - closing Exhaust valve timing: - opening - closing	8 deg. before TDC 52 deg. after BDC 46 deg. before BDC 20 deg. after TDC

Table 1. Technical and operational data of MD-111E engine

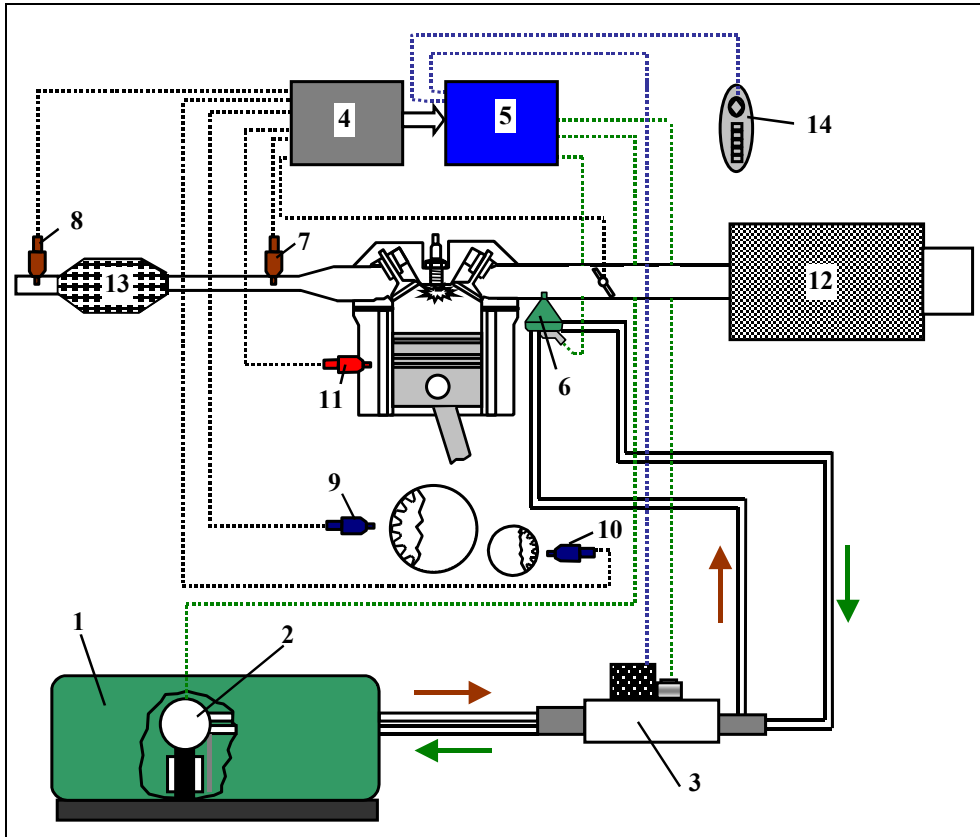

Figure 1. Scheme of VIALLE fuelling system (Vialle, 2001): 1 – LPG tank, 2 – LPG pump, 3 – fuel pressure regulator, 4 – petrol ECU, 5 – LPG ECU, 6 – LPG injector, 7 – first oxygen sensor, 8 – second oxygen sensor, 9 – engine speed sensor, 10 – camshaft position sensor, 11 – coolant temperature sensor, 12 – air filter, 13 – exhaust gas catalyst, 14 – fuel type switch

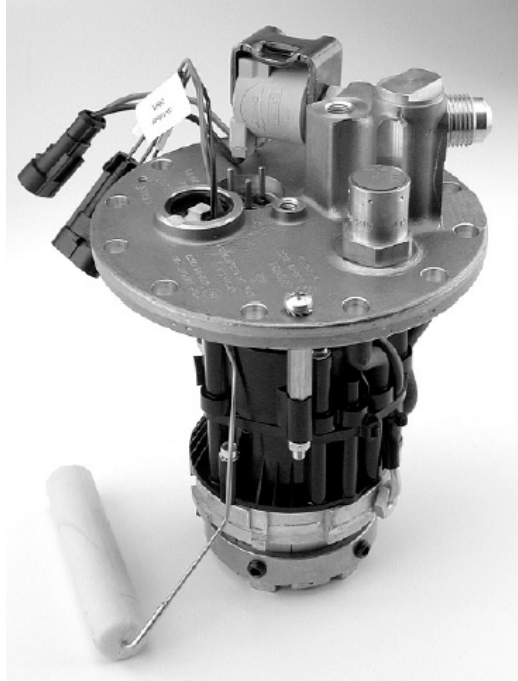

Figure 2. Unit of LPG pump (Vialle, 2001)

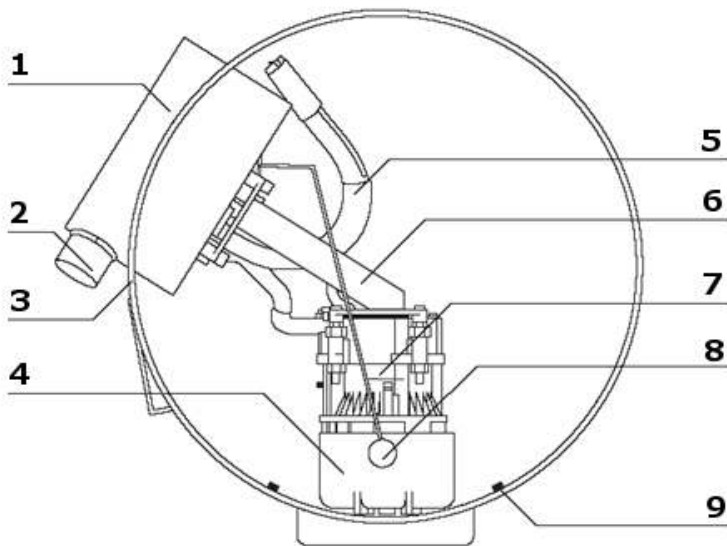

Figure 3. Scheme of tank with fuel pump (Vialle, 2001): 1 – pump body, 2 – inlet of body, 3 – tank wall, 4 – distance sleeve, 5 – inlet pipe, 6 – pump holder, 7 – pump, 8 – float, 9 – magnet

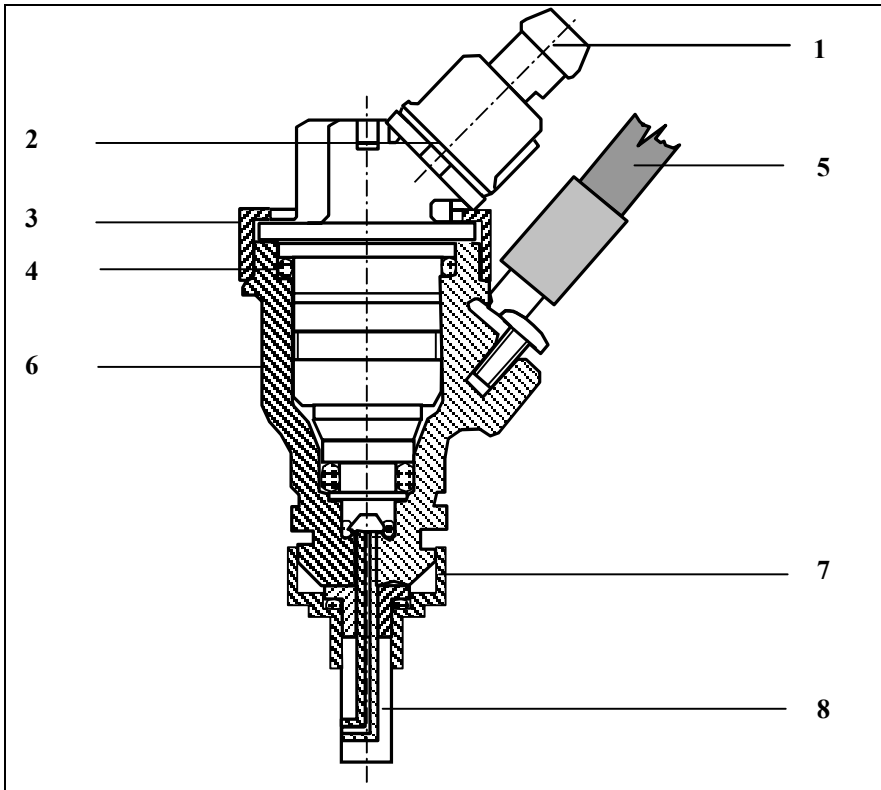

Figure 4. Scheme of LPG liquid phase injector (Vialle, 2001): 1 – electrical connection, 2 – injector body, 3 – ring fixing the injector to body, 4 – o-ring, 5 – fuel inlet socket, 6 – injector housing, 7 – adapter, 8 – outlet pipe

The pressure regulator includes solenoid valve opened and closed when the output valve of the tank is turned on. The pressure regulator is also a pressure control module and the pressure sensor. The liquid gas flows through the valve to the injectors and the excess returns via a pressure regulator to the tank. The pressure is keeping by the controller by 5 bars higher than the pressure in the tank and can be 7-30 bars (Cipollone & Villante, 2000; Vialle, 2001). For the injection of gas in liquid phase there were used the low-pass injectors which distinct from top-pass injectors commonly used in petrol fuel systems, the fuel is delivered below the injector coil. This causes less heating of the gas from the coil, which favors keeping the liquid phase in the injector. To prevent coarse pollutions the filter was placed before the inlet of gas into the injector (Fig. 4). Due to the low resistance of the injector coil, the pulse control was applied to reduce the currents flowing during operation of the injector. The gas is fed to the injectors with synthetic pipes which are fixed with reinforced plates to each other and are locked with screws. Because the exhaust manifold is located above the intake manifold, the injectors were mounted into the intake manifold from below near to the cylinder head. It allows to lead the gas almost directly onto the inlet valve.

3. Test stand and research method

The goal of realized study was to determine the effect of injection timing on ecological parameters of the engine. The test stand with dynamometer has been equipped with the following functional units and measurement systems:

- hydraulic dynamometer Schenck D 630 with the control system,
- exhaust gas analysis system consisting of the following elements:
 - Chemiluminescent NO_x analyzer of the type Pierburg CLD PM 2000,
 - Flame ionization hydrocarbon analyzer FID HC type of PIERBURG PM 2000,
 - four-gas exhaust gas analyzer (CO, CO₂, HC, O₂) of the type Bosch BEA 350 equipped with function for calculating the ratio of actual AFR to stoichiometry (Lambda) for the various fuels,
- LPG fuel consumption measuring system with Coriolis sensors,
- flow measurement system of the intake air,
- temperature measurement system,
- pressure measurement system.

The engine mounted to the test stand (Fig. 5) is shown in figure 6.

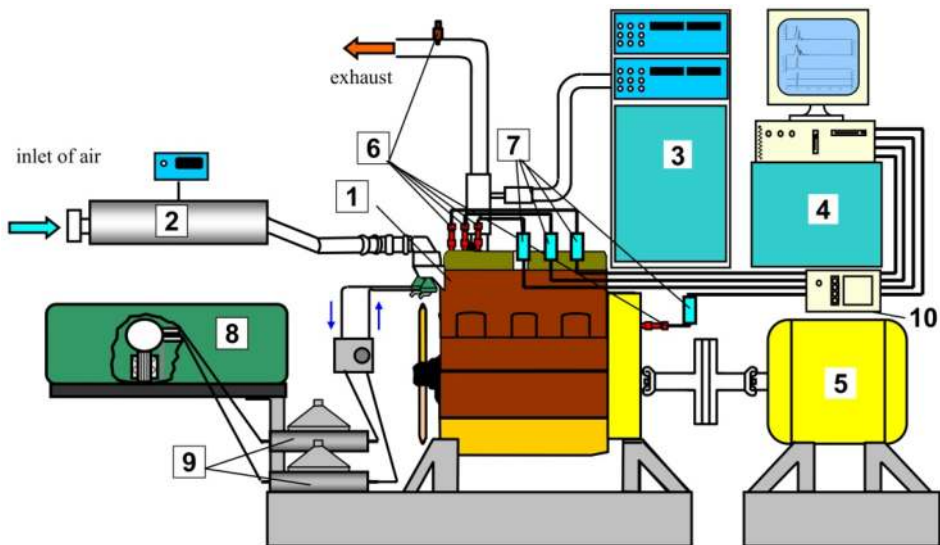

Figure 5. Schema of test stand: 1 - engine, 2 - air flow meter, 3 - combustion gases analyzers, 4 - computer with data acquisition system, 5 - brake, 6 - measuring sensors, 7 - measuring amplifiers, 8 - container of LPG, 9 - fuel flow measurement, 10 - separator of signal

During tests the measurements of following exhaust ingredients were made: oxides of nitrogen (NO_x), hydrocarbons (HC) and carbon monoxide (CO). Additionally, engine noise level was determined. Primarily the measurements was conducted for engine speed of $n = 1500$ rpm, required for co-operation with a power generator and with different loads.

An important parameter that affects both the operating parameters and the exhaust toxicity for sequential injection is the start of fuel injection (Hyun et al., 2002; Oh et al., 2002). For this reason a large part of the measurements was the analysis of the impact of the start of injection on obtained engine parameters and the emission of toxic ingredients in exhaust gases. The tests were performed with single and double injection. The start of injection was changed within the range shown in figure 7 and 8.

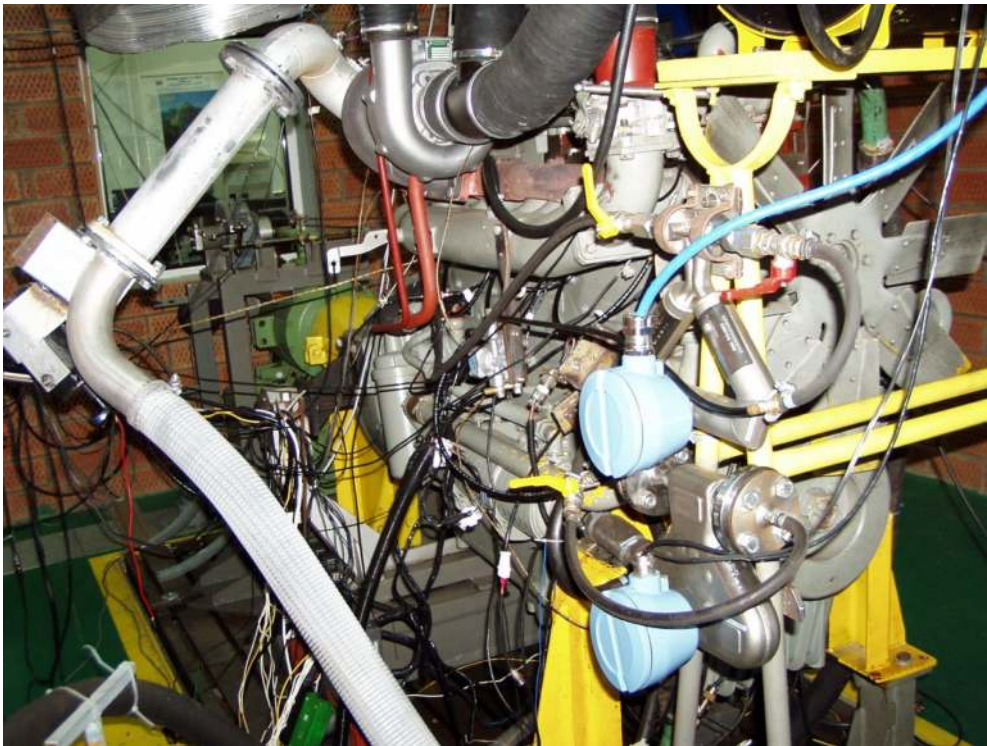

Figure 6. MDE-11 engine with sequence LPG injection system (for liquid phase) during test on stand

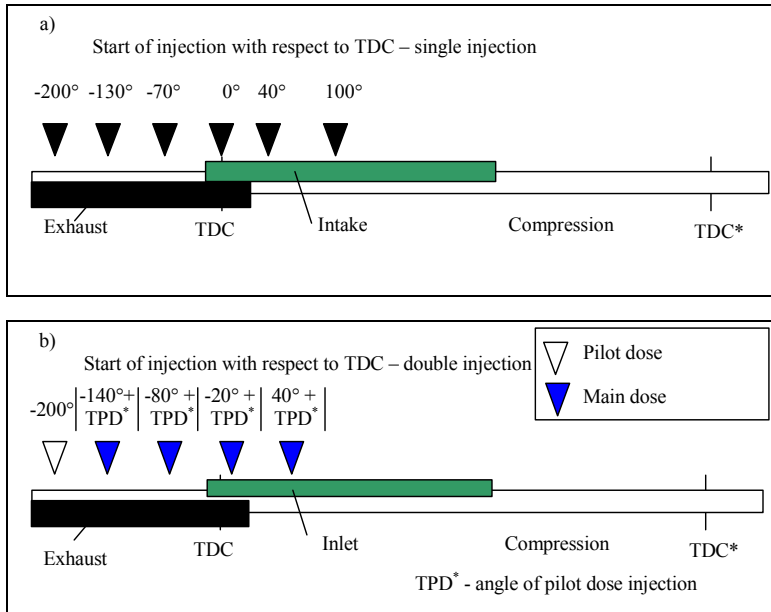

Figure 7. Tested injection starts with first signal disk sensor position: a) for single injection, b) for dual injection

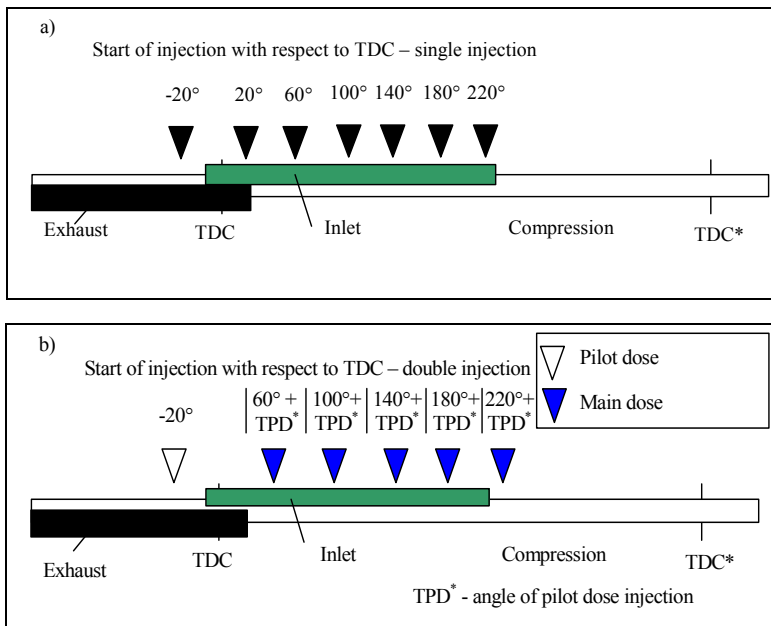

Figure 8. Tested injection starts with second signal disk sensor position: a) for single injection, b) for dual injection

The measurement of noise level was realized with AS-120 meter located at a height of 1 m and 1 m from the engine on the side of electrical starter motor. The sound level was measured using a filter correction L_A [dB] and without correction L [dB]. The microphone for sound recording was placed in the axis of the engine, between 3 and 4 cylinder, at distance of 1 m from the valve cover. There was used microphone AKG C1000S (Shure Beta-58) for sound recording cooperating with amplifier Behringer MX1804X and octave filter RFT OF 101-01000. The recording was performed with 16-bit sound card.

4. Test results

Fig. 9 and 10 presents the performance of the engine, and fig. 11-14 shows the contour map (generalized performance map) for specific fuel consumption and the concentration of carbon monoxides, oxides of nitrogen and hydrocarbons. As we can see the maximum brake torque of the engine is larger than 770 Nm at an engine speed of 900 rpm and the maximum brake power of the engine is 125 kW at an engine speed of 1700 rpm.

Specific fuel consumption for an engine speed of 1500 rpm which is relevant to power generator is lowest at the maximum load and amounts to approximately 265 g/kWh. For this engine speed, the maximum CO concentration is approximately 0.3% and is higher at large loads. The concentration of NO_x for mentioned engine speed ranges is from 40-550 ppm, reaching 160 -250 ppm for the large and medium loads. Hydrocarbon concentration amounts to from 15 ppm at small loads, up to 75 ppm at loads close to maximum.

The relationship between the injection starts of the LPG in liquid phase into a inlet manifold pipes and the concentration of CO₂, CO, HC and NO_x in the exhaust is shown on figures 15 and 16. At the starts of injection carried out at the opening of the intake valve, an increase in the concentration of NO_x and hydrocarbons HC was observed versus the injection starts realized before opening the intake valve (fig. 15). The concentrations of CO and CO₂ were undergone a slight changes in this case. At the injection starts carried out at the opening of the inlet valve is visible increase in the concentration of NO_x at injection starts carried out from about 60 to 100 CA deg. after TDC during the intake stroke. Moreover an increase in the concentration of hydrocarbon HC and carbon monoxide CO at the injection starts carried out in the phase of closing the inlet valve from about 140 to 180 CA deg. after TDC at inlet stroke was observed (fig. 16). The injection realized at closing the inlet valve is also connected with the reduction of CO₂ concentration.

Basing on the results for engine parameters and concentrations of hydrocarbons HC, oxides of nitrogen NO_x, carbon monoxide CO in exhaust gas a right specific emissions were calculated. The calculation course of the specific emission was determined based on a set of International Standards ISO 8178 (ISO, 1999-2001). The calculation results are shown in figures 17-22.

The injection starts realized at closing the inlet valve (fig. 17 and 20) cause the increase in specific hydrocarbons emissions. Specific hydrocarbons emission decreases with increasing the injection duration (fuel quantity). Moreover we can see that specific NO_x emission

increases with long injection durations (higher load) and the injection starts realized at the opening of the inlet valve (fig. 18 and 21).

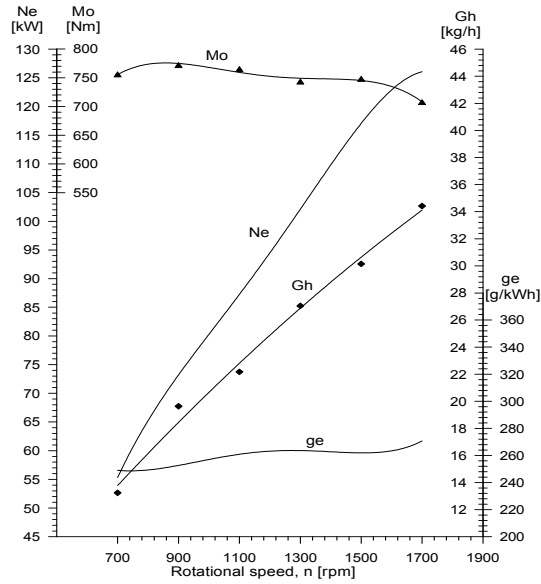

Figure 9. MD-111E engine WOT diagram for double injection: Ne – engine power, Mo – torque, Ge – fuel consumption, ge – specific fuel consumption

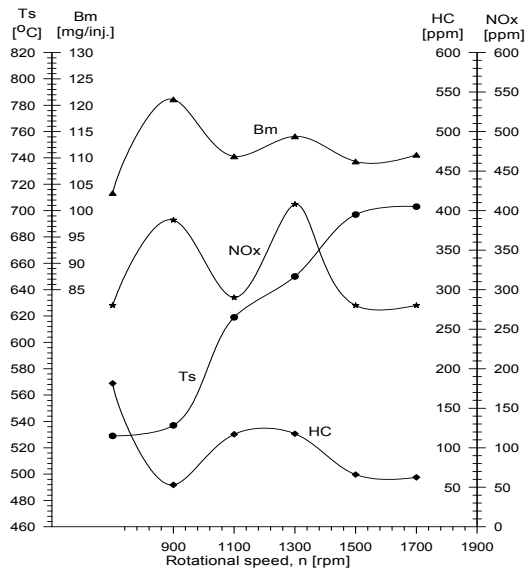

Figure 10. MD-111E engine parameters for WOT operation: Ts – exhaust temperature, Bm – fuel amount HC – hydrocarbons, NOx – nitric oxides

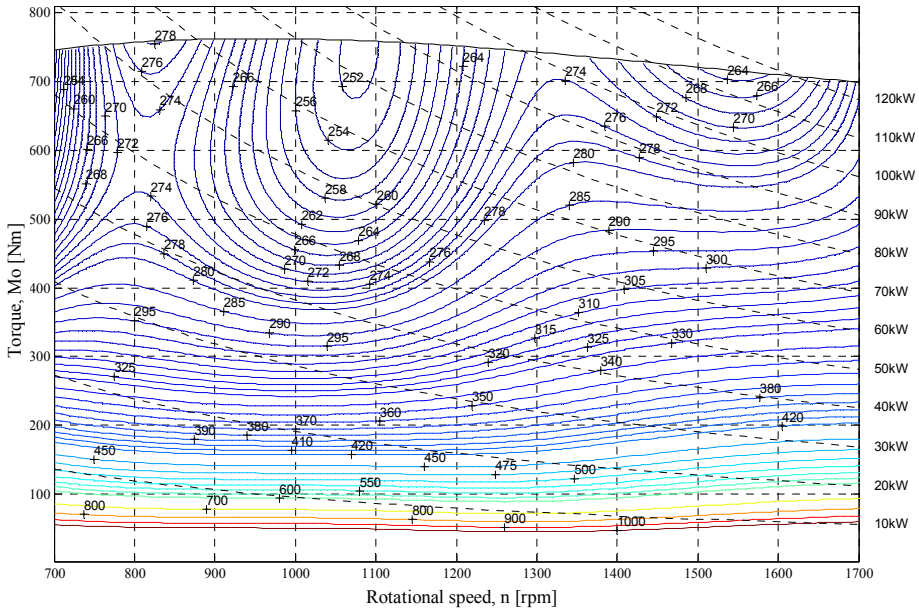

Figure 11. Generalized performance map of MDE-111E LPG engine equipped with sequential injection system and catalytic converter

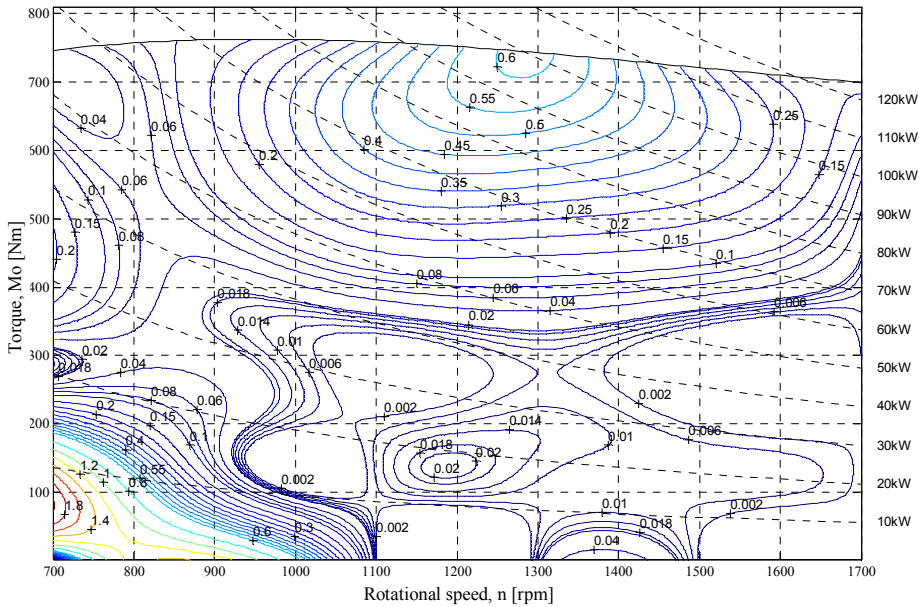

Figure 12. Contour map for concentration of monoxide carbon for MDE-111E LPG engine equipped with sequential injection system and catalytic converter

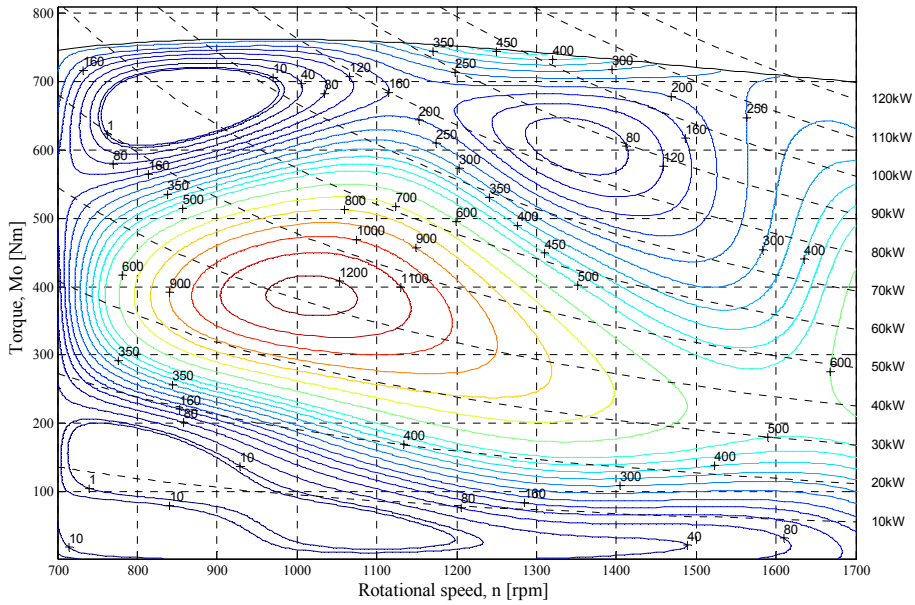

Figure 13. Contour map for concentration of oxides of nitrogen for MDE-111E LPG engine equipped with sequential injection system and catalytic converter

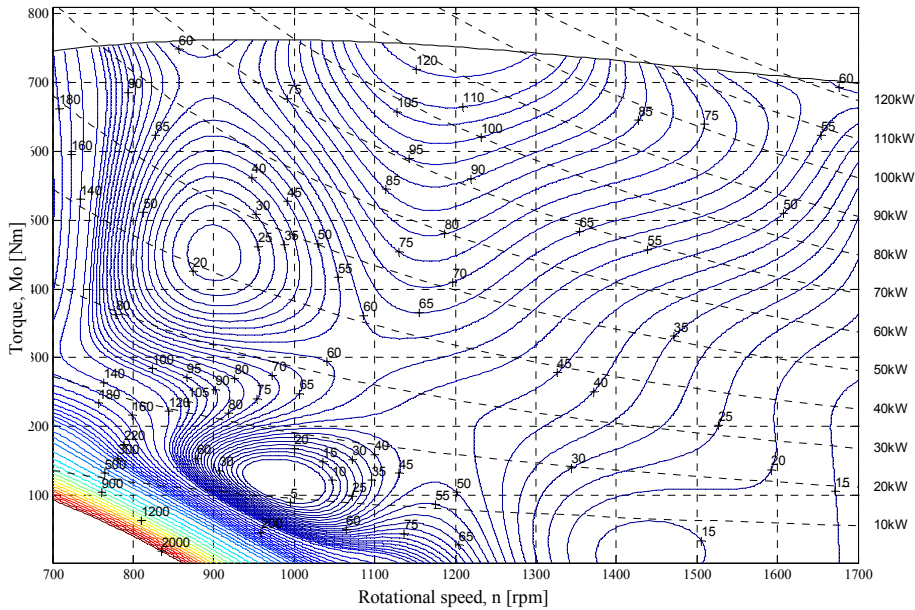

Figure 14. Contour map for concentration of hydrocarbons for MDE-111E LPG engine equipped with sequential injection system and catalytic converter

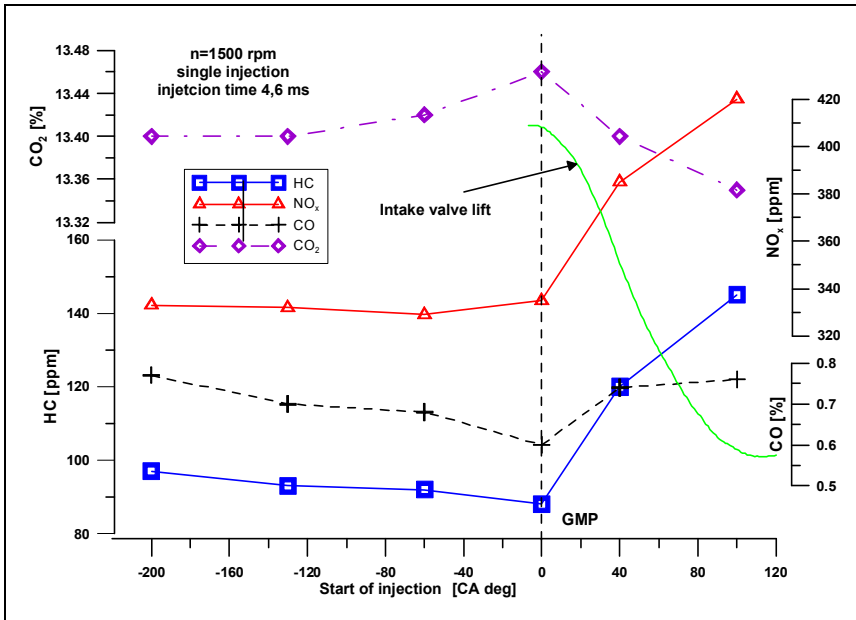

Figure 15. The effect of injection start on the concentration of CO, CO₂, HC, NO_x in the exhaust gas (single injection, n=1500 rpm, injection duration 4.6 ms) – for LPG in liquid phase

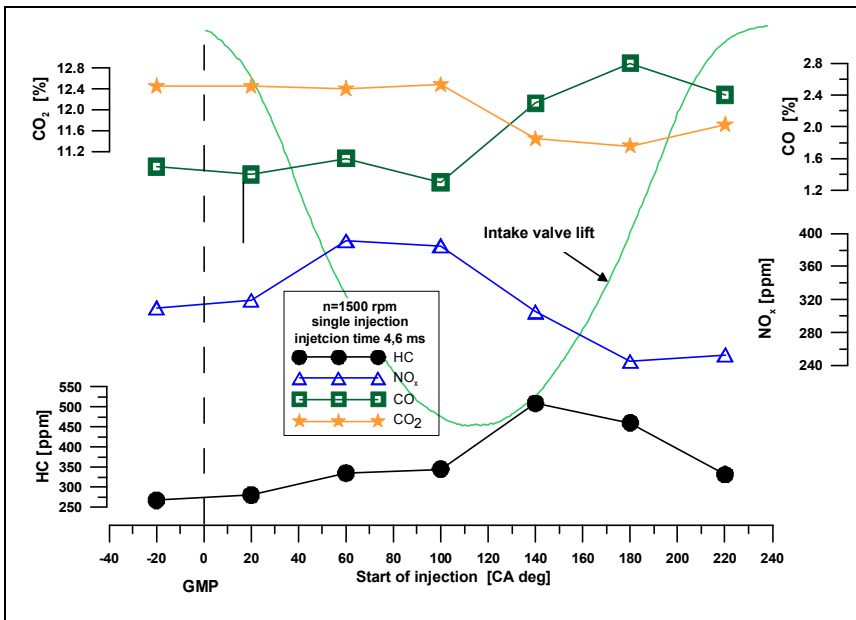

Figure 16. The effect of injection start on the concentration of CO, CO₂, HC and NO_x in the exhaust gas (single injection, n=900 rpm, injection time 5,5 ms) – for LPG in liquid phase

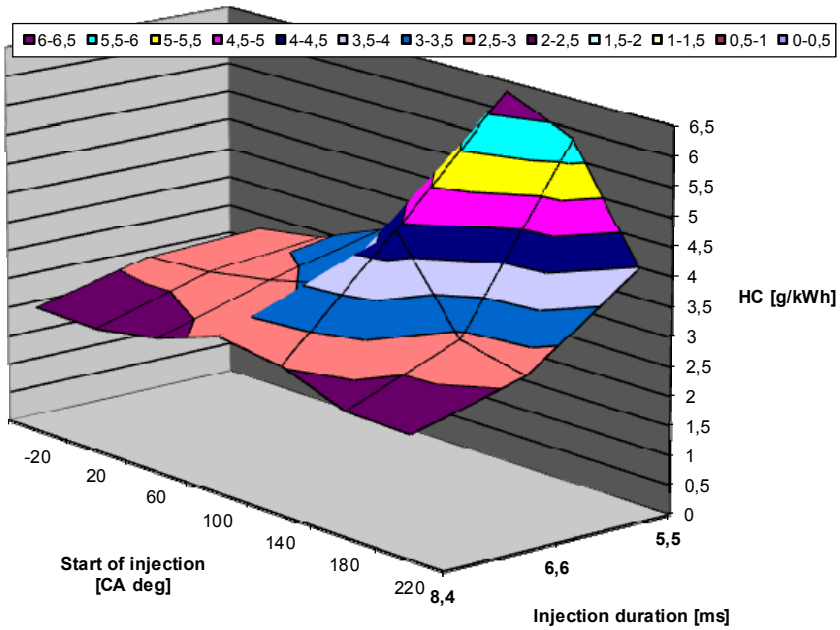

Figure 17. Specific HC emission for the selected injection parameters (single injection, n=900 rpm)

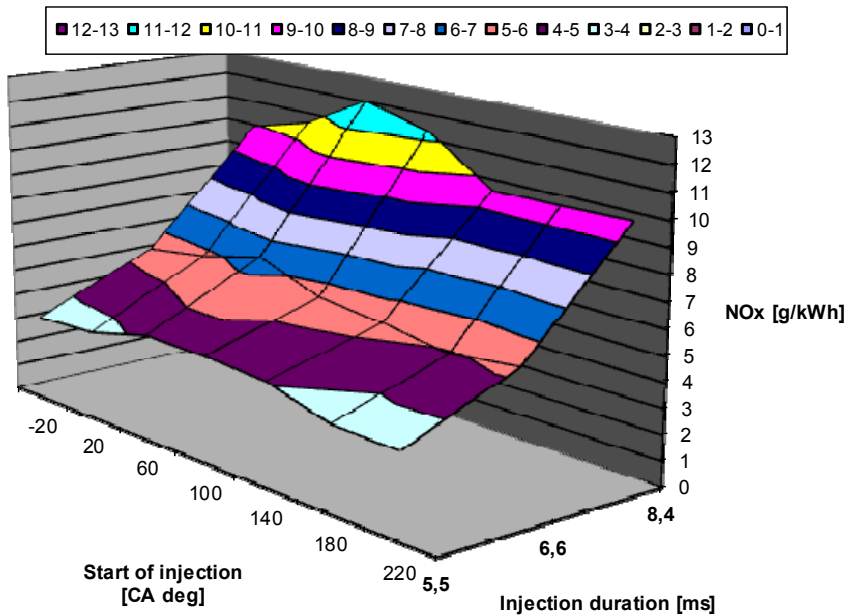

Figure 18. Specific NO_x emission for the selected injection parameters (single injection, n=900 rpm)

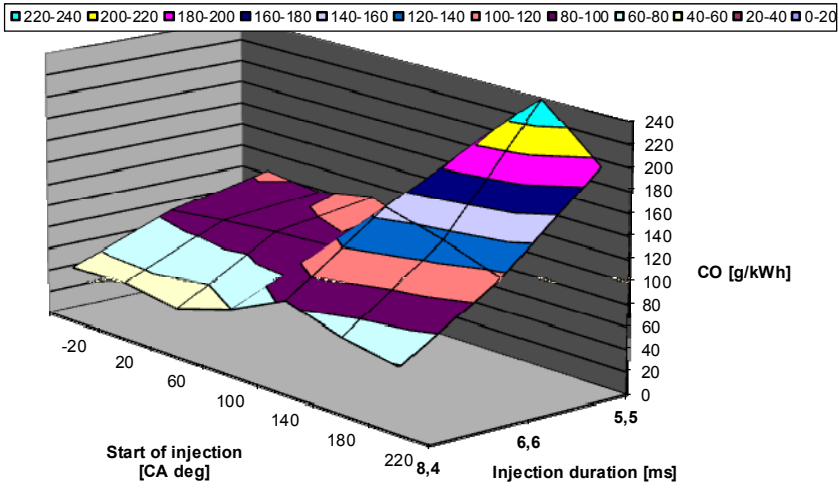

Figure 19. Specific CO emission for the selected injection parameters (single injection, n=900 rpm)

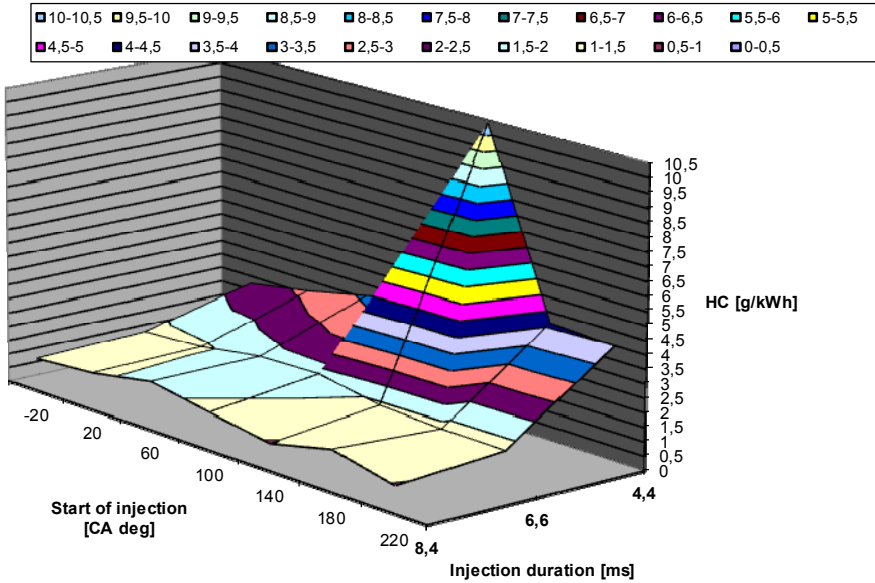

Figure 20. Specific HC emission for the selected injection parameters (single injection, n=1500 rpm)

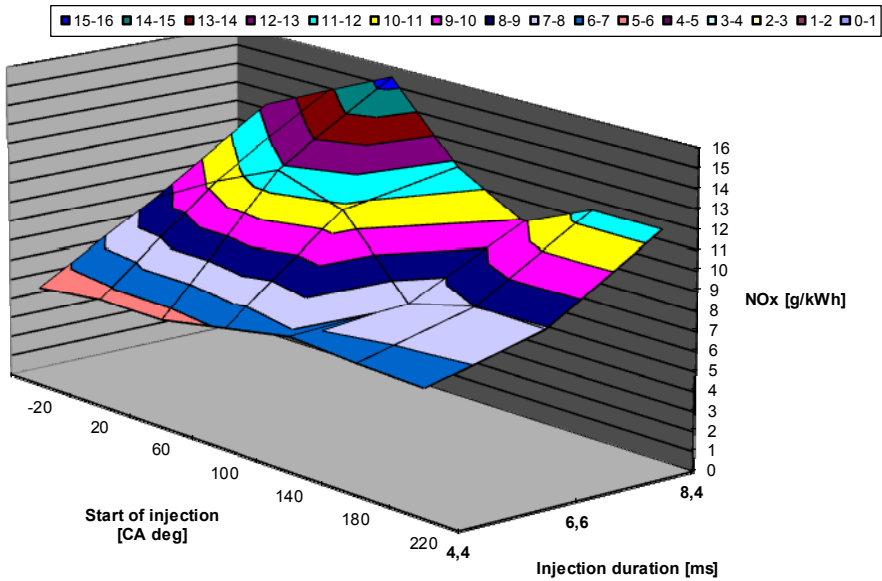

Figure 21. Specific NO_x emission for the selected injection parameters (single injection, n=1500 rpm)

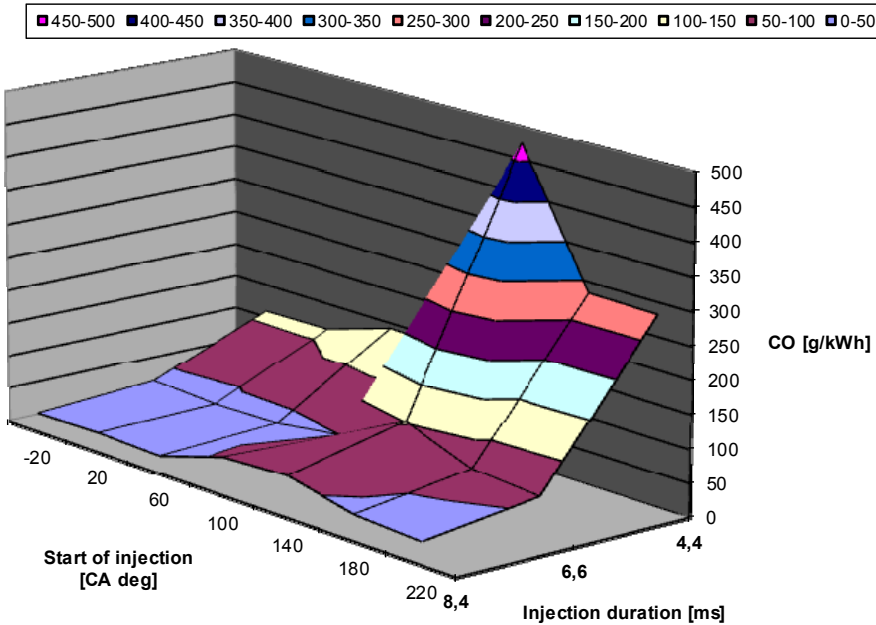

Figure 22. Specific CO emission for the selected injection parameters (single injection, n=1500 rpm)

At injection starts realized at closing the inlet valve the increase in specific CO emission is observed (fig. 19 and 22). The investigations show that specific CO emission decreases with injection duration (low load).

Table 2 presents the results of investigations on the effect of pilot and main injection on noise level generated by the engine. The study was conducted for an engine speed of $n = 1500$ rpm and three different loads – maximum, close to half of the maximum and not more than 10% of the maximum load. There was changed pilot injection advance α_{pp} relative to TDC (in the intake stroke), and the distance between pilot and main injection $\Delta\alpha_{pz}$. The study was conducted at a fixed value of ignition advance $\alpha_{wz} = 20$ CA deg.

n [rpm]	M _o [Nm]	t _{inj} [ms]	α_{pp} [CA deg]	$\Delta\alpha_{pz}$ [CA deg]	α_{wz} [CA deg]	L _A [dB]	L [dB]
1499	10,7	4,4	285	100	20	98	102
1491	6,6	4,6	285	30	20	98	102
1498	7,7	4,4	285	160	20	98	102
1500	45,4	4,6	225	100	20	97	101
1501	336,0	10,2	285	100	20	98	102
1501	337,5	10,4	285	30	20	98	102
1500	329,2	10,4	285	160	20	97	101
1501	349,3	10,8	225	100	20	97	100
1500	735,0	18,0	285	100	20	97	100
1501	714,9	18,2	285	30	20	97	100
1501	713,8	18,2	285	160	20	97	101
1500	728,2	17,2	225	100	20	97	101

Table 2. The effect of pilot and main injection timing on noise level of the engine

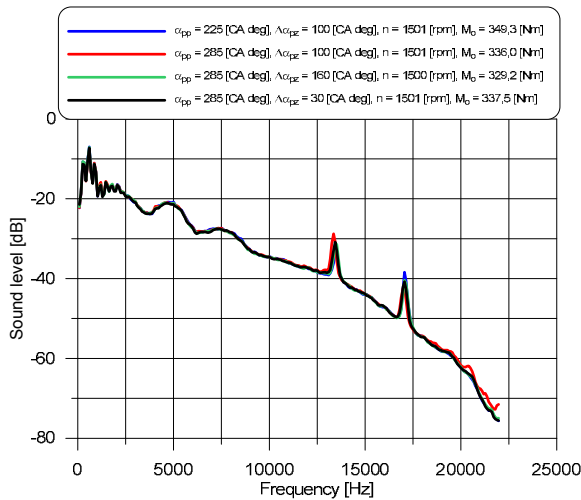

Figure 23. Frequency spectrum of sound level at various injection timing

From table 2 and fig. 23 we can see that at an engine speed of 1500 rpm, regardless of the load, both the start injection of pilot fuel quantity α_{pp} and the start injection of main fuel quantity (characterized by the value of $\Delta\alpha_{pz}$) do not have significant effect on the sound level and its frequency.

5. Conclusions

The tested engine MD-111E reaches more than 125 kW at maximum tested speed, but at a speed of 1500 rpm, when cooperates with a power generator has a power output of 115 kW, what allows to cooperate with a power generator with a capacity of 125 kVA providing a sufficient surplus of power.

The researches show, that injection timing has a significant relationship with the emission of toxic ingredients in exhaust gases of the engine. LPG fuel injection carried out at closing of intake valve causes an increase in specific HC emission and specific CO emission. For the injection starts realized at opening of the intake valve an increase in the specific NOx emission is observed. Realized researches show, that at an engine speed of 1500 rpm, regardless of the load, both the start injection of pilot fuel quantity and the start injection of main fuel quantity do not have significant effect on the sound level and its frequency.

The final value of timing and mutual location of the fuel quantities (for pilot and main injection) with respect to TDC of the piston can be selected only because of the optimal operation and environmental performances of the engine. It greatly simplifies the problem of optimization of the ignition system and fuel injection system designed to fuelling using LPG in liquid phase at sequential injection system and at split of injection.

The application of fuel system with dual LPG sequential injection of liquid phase and the catalytic converter can achieve satisfactory environmental performances of the engine. The use of a turbocharger gives the possibility to increase the engine power obtained in broad range of engine speed with small modifications of fuel system.

The use of broadband oxygen sensor instead of the two state oxygen sensor can improve the control accuracy and precision of fuel delivery. In this way can be met more and more rising requirements connected with emission standards.

Author details

Artur Jaworski, Hubert Kuszewski, Kazimierz Lejda and Adam Ustrzycki
Rzeszów University of Technology, Faculty of Mechanical Engineering and Aeronautics,
Department of Automotive Vehicles and Internal Combustion Engines, Poland

6. References

Cipollone, R., & Villante, C. (2000). *A/F and Liquid-Phase Control in LPG Injected Spark Ignition ICE*. SAE Technical Paper 2000-01-2974

- Cipollone, R., & Villante, C. (2001). A dynamical analysis of LPG vaporization in liquid-phase injection systems. *International Workshop on "Modeling, Emissions and Control in Automotive Engines" MECA'01*, University of Salerno, Italy, September 2001
- Dutczak, J., Golec, K., & Papuga, T. (2003). Niektóre problemy związane z wtryskowym zasilaniem silników ciekłym propanem-butanem. *VI Międzynarodowa Konferencja Naukowa SILNIKI GAZOWE 2003*, Zeszyty Naukowe Politechniki Częstochowskiej, pp. 296-303, ISBN 83-7193-208-1, Częstochowa, 2003
- Hyun, G., Oguma, M., & Goto, H. (2002). 3-D CFD analysis of the mixture formation process in an LPG DI SI engine for heavy duty vehicles. *Twelfth International Multidimensional Engine Modeling User's Group Meeting Agenda*, Detroit, 2002
- Lee, E., Park, J., Huh, K.Y., Choi, J., & Bae, C. (2003). *Simulation of fuel/air mixture formation for heavy duty liquid phase LPG injection (LPLI) engines*. SAE Technical Paper 2003-01-0636
- Oh, S., Kim, S., Bae, C., Kim, C., & Kang, K. (2002). *Flame propagation characteristics in a heavy duty LPG engine with liquid phase port injection*. SAE Technical Paper 2002-01-1736
- PN-EN ISO 8178, part 1-4, 1999-2001
- Training materials of Vialle. Kielce, 2001