

New Trend in the Development of ME-TVC Desalination System

Anwar Bin Amer
*Kuwait Foundation for the Advancement of Sciences (KFAS),
Research Directorate,
Water Resources Program
Kuwait*

1. Introduction

Several low temperature Multi-Effect Thermal Vapor Compression (ME-TVC) desalination units have been installed recently in most of the GCC countries. The total installed capacity has increased up to 500 million imperial gallons per day (MIGD) between 2000 and 2010 as shown in (Table 1). The majority of these units were commissioned in the UAE by SIDEM Company. The unit size capacities of these units were increased exponentially from 1 to 8.5 (MIGD) between 1991 and 2008 as shown in Fig.1. The new trend of combining ME-TVC with conventional multi-effect units led to this tremendous increase, more than eight times, during a very short period. Moreover, the unit size capacity of this technology is currently available with 10 MIGD, and it is expected to increase up to 15 MIGD in the near future. Hence, this system has become highly attractive and competitive against Multi Stage Flash (MSF) desalination system and it is predicted to get a considerable increase in the desalination market in future, particularly, in the GCC countries because it includes the following attractive features:

- Operates at lower top brine temperature around 60 to 70 °C compared to 90 to 120 °C in the MSF, and this reduces the scale formation, corrosion problems, anti-scalant chemicals and maintenance shutdown time (Darwish & Alsairafi, 2004).
- Requires less pumping energy than MSF (1.5~2 kW/m³ compared to 4~5 kW/m³), because there is no need to re-circulate large quantities of brine as in MSF system.
- Produces higher gain output ratios (GOR) up to 16 with less number of effects compared to 8 GOR and 21 stages in the MSF (Wade, 2001).
- Uses falling film horizontal tube evaporator (HTE), which gives high heat transfer coefficient and reduces the needed heat transfer area and consequently the capital cost of the desalination plant (Reddy & Ghaffour, 2007).
- Better response to steam supply variation, so, it has more flexibility of operation than MSF (Darwish & Alsairafi, 2004).

Table1 shows that ME-TVC technology is gaining more market shares recently in Bahrain, Saudi Arabia and Qatar with a total installed capacity of 60 MIGD, 176 MIGD and 63 MIGD, respectively.

Year	Location	Country	Unit capacity	No. of units	Total capacity	GOR
1991	Jabal Dhana	UAE	1 MIGD	4	4 MIGD	8
2000	Umm Al-Nar	UAE	3.5 MIGD	2	7 MIGD	8
2001	Layyah	UAE	5 MIGD	2	10 MIGD	8
2002	Al-Taweelah A ₁	UAE	3.7 MIGD	14	52 MIGD	8
2005	Sharjah	UAE	8 MIGD	2	16 MIGD	8.4
2006	Al-Hidd	Bahrain	6 MIGD	10	60 MIGD	8.9
2007	Al-Jubail	Saudi Arabia	6.5 MIGD	27	176 MIGD	9.8
2008	Fujairah	UAE	8.5 MIGD	12	100 MIGD	10
2009	Ras Laffan	Qatar	6.3 MIGD	10	63 MIGD	11.1

Table 1. Several projects of ME-TVC commissioned by SIDEM in the GCC countries.

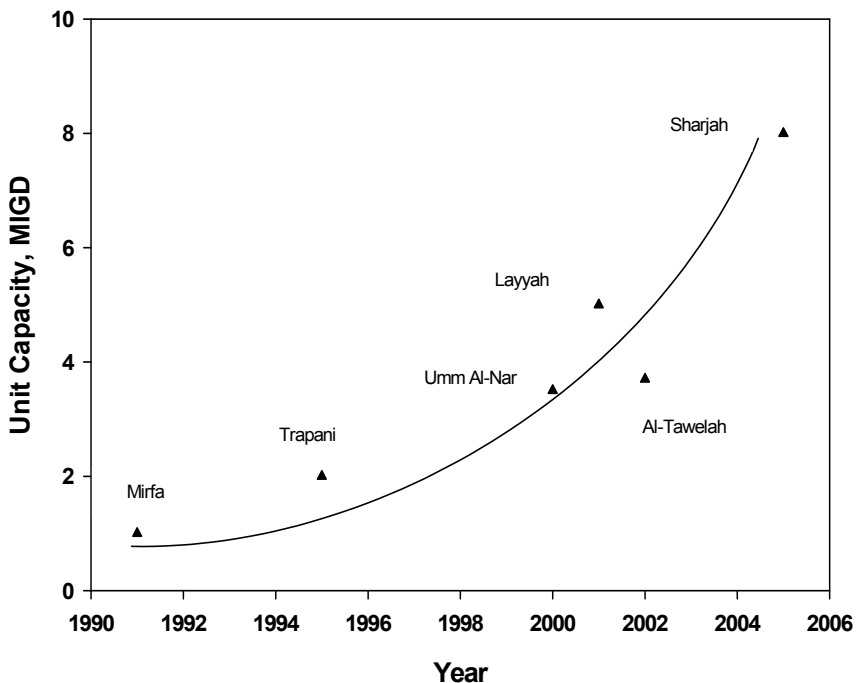

Fig. 1. The increase of unit size capacity of ME-TVC desalination systems.

2. Literature review

Several studies have been published since the early of 1990's concerning ME-TVC desalination system. Some of which include field studies others describe different conceptual designs. Diverse mathematical models have been developed since then, in most of these publications for simulation and economic evaluation purposes. A summary

literature review of these studies were reported in (Al-Juwayhel et al, 1997) and (El-Dessouky & Ettouney, 1999). On the other hand, limited studies were published handling ME-TVC desalination system from exergy (Second Law) point of view since the middle of last decade, but it has been carried out in several published works recently.

(Hamed et al., 1996) conducted and evaluated the performance of a ME-TVC desalination system. An exergy analysis was also performed and compared with conventional multi effect boiling (MEB) and mechanical vapor compression (MVC) desalination systems. Results showed that the ME-TVC desalination system is the most exergy-efficient compared to other systems.

(Al-Najem et al., 1997) conducted a parametric analysis using First and Second Laws of Thermodynamics for single and multi effect thermal vapor compression system (ME-TVC). The study revealed that the steam ejector and evaporators are the main source of exergy destruction in the ME-TVC desalination system.

(Alasfour et al., 2005) developed mathematical models for three configurations of a ME-TVC desalination system using energy and exergy analysis. A parametric study was also performed to investigate the impacts of different parameters on the system performance. Results showed that the first effect was responsible for about 50 % of the total effect exergy destructions. The parametric study also showed that the decrease in exergy destructions is more pronounced than the decrease in the gain output ratio at lower values of motive steam pressure. Lowering the temperature difference across the effects, by increasing the surface area, decreases the specific heat consumption. On the other hand, exergy losses are small at low temperature difference and low top brine temperature.

(Choi et al., 2005) presented an exergy analysis for ME-TVC pilot plant units, which was developed by Hyundai Heavy Industries Company. The units have different capacities of 1, 2.2, 3.5 and 4.4 MIGD. Exergy analysis showed that most of the specific exergy losses were in thermal vapor compressor and the effects. The amount of exergy destruction represents more than 70% of the total amount. Results also showed that the increase of entrainment ratio to 120% will decrease the total heat transfer area by 12%.

(Wang & Lior, 2006) presented the performance analysis of a combined humidified gas turbine (HGT) plant with ME-TVC desalination systems using Second Law of thermodynamics. The analysis is performed to improve the understanding of the combined steam injection gas turbine power and water desalination process and ways to improve and optimize it. Results showed that the dual purpose systems have good synergy in fuel utilization, in operation and design flexibility.

(Sayyaadi & Saffari, 2010) developed thermo-economic optimization model of a ME-TVC desalination system. The model is based on energy and exergy analysis. A genetic algorithm is used to minimize the water product cost.

This chapter describes and discusses new developments which have taken place recently in the design, operation and material selection of ME-TVC units. A mathematical model of a ME-TVC desalination system is also developed in this chapter, using Engineering Equation Solver (EES) Software. This model is used to evaluate and improve the performance of some new commercial ME-TVC units having capacities of 2.4, 3.5 and 6.5 MIGD using energy and exergy analysis. The model results were compared against the actual data which showed good agreement. The other aim of this chapter is to develop a mathematical optimization model using MATLAB program. The model is used to determine the optimum operating and design conditions of different numbers of effects to maximize the gain output

ratio of the ME-TVC unit, using two optimization approaches: (1) Smart Exhaustive Search Method (SESM) and (2) Sequential Quadratic Programming (SQP).

3. Process description

The arrangement of combining the ME-TVC with conventional Multi-effect consists of two separate rows of effects, each packed into one circular/rectangular vessel along with a thermo-compressor. Both vessels are connected parallel with a third vessel in the middle, which contains a number of effects along with the end condenser.

A schematic diagram of this arrangement is shown in Fig. 2, where two identical ME-TVC units are combined with a single MED unit, where as the vapor produced in the last effect of each ME-TVC unit (D_j) is split into two streams. The first stream D_r is entrained by a thermo-compressor and other part (D_f) is used as a heat source to operate low temperature multi effect distillation unit (LT-MED).

The configuration consists of the following components (1) a number of horizontal falling film evaporators (n effects), (2) two thermo-compressors, (3) a number of feed heaters, (4) five main pumps (distillate, feed, condensate, cooling and brine disposal pumps) to circulate the streams, (5) an end condenser and (6) a number of flashing boxes.

Two streams of motive steam (D_s) are directed at relatively high motive pressure (P_s) into two thermo-compressors. The motive steam is supplied usually either from boiler or steam turbine. Part of the vapor formed in the last effect (D_r) of each ME-TVC unit, is entrained and compressed by the thermo-compressor as mentioned above along with the motive steam (D_s+D_r) into the first effect of each unit where it condenses. The latent heat of condensation is used to heat the feed F_1 from T_{f1} to the boiling temperature T_1 and evaporates part of that feed by boiling equal to D_1 . Part of the condensate (D_s) returns to its source and the other part of the condensed vapor (D_r) is introduced to the first flashing box, where a small amount of vapor flashes off due to pressure drop and equal to $D_r y$, where $y=C\Delta T/L_1$. This flashing vapor is passed through the first feed heater along with the vapor formed in the first effect ($D_1+D_r y$) heating the feed F_1 from T_{f2} to T_{f1} ; then part of it condenses, and the remaining vapor ($D_1+D_r y -F_1 y$) flows as a heating source to the second effect and so on up to the last effect n . The brine leaving the first effect (B_1) is directed to the second effect which is at a lower pressure, so that flashing will release additional vapor, which is theoretically equal to $B_1 C \Delta T/L_2$. This process is continued up to the last effect n . In this configuration, the condensate vapor in each feed heater is assumed to be equal to vapor flashed between the two effects from both accumulated distillate and the brine. This gives an increase in temperature across the feed heaters, which equal to the temperature drop between the effects i.e. ($\Delta T_{fi} = \Delta T$).

The vapor formed in the last effect D_n flows into the end condenser where it condenses by the cooling seawater stream M_c . The latent heat of condensation is used to heat the seawater temperature from T_c to T_f . Part of the cooling stream flows to the effects (F) where it is heated in a series of feed heaters and the remainder (M_c-F) is rejected from the system.

The feed seawater flow (F) rate splits equally into each effect. Each part sprayed over a horizontal tube bundle through nozzles, the spray forms a thin falling film over the tubes of the bundle. The formation of this thin film enhances the heat transfer rate and makes the evaporation process more efficiently. Series feed heaters are also used between the effects to

increase the feed seawater temperature and consequently decrease the energy added for evaporation.

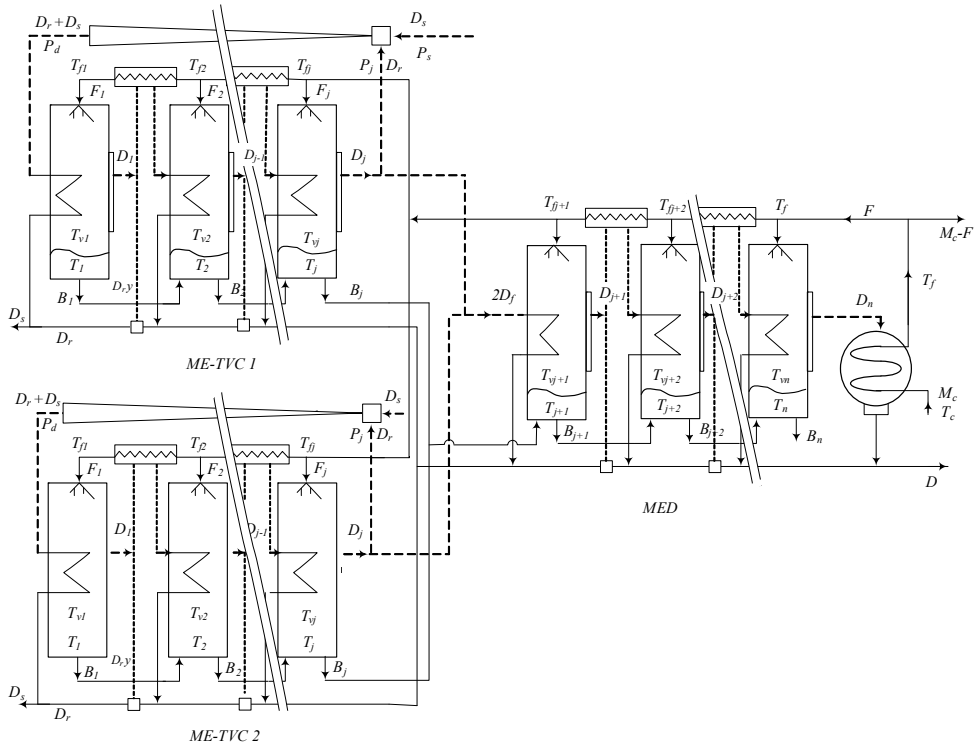

Fig. 2. A schematic diagram of two ME-TVC units combined with a conventional MED unit.

4. Thermal analysis of ME-TVC desalination system

First and Second Laws analysis are used in this section to develop a mathematical model of the ME-TVC desalination system. The model is developed by applying mass and energy conservation laws to the thermo-compressor, evaporators, feed heaters and end condenser. The following assumption were used to simplify the analysis: steady state operation, negligible heat losses to the surrounding, equal temperature difference across feed heaters, salt free distillate from all effects and variations of specific heat as well as boiling point elevation with the temperature and salinity are negligible.

The brine temperature in each effect is less than that of the previous one by ΔT . So, if the brine temperature in the effect i is assumed to be T_i , then the brine temperature in the next effect $i+1$ and so on up to the last effect n and can be calculated as follow:

$$T_{i+1} = T_i - \Delta T, \quad i = 1, 2, \dots, n \quad (1)$$

The temperature of the vapor generated in the effect i , T_{vi} is lower than the brine temperature by the boiling point elevation plus non equilibrium allowance, where T_{vi} is a saturation temperature corresponding to the pressure in the effect P_i .

$$T_{vi} = T_i - (BPE + NEA), \quad i = 1, 2, \dots, n \quad (2)$$

The temperature difference between the effects is assumed to be the same in this analysis and can be calculated as follows:

$$\Delta T = \frac{T_1 - T_n}{n - 1} \quad (3)$$

The feed seawater temperature flowing into each effect (T_{fi}) can be calculated as follows:

$$T_{fi} = T_f + [n - (i + 1)] \cdot \Delta T \quad i = 1, 2, 3, \dots, n \quad (4)$$

4.1 Mass and Energy Balance

The feed seawater flow rate F is distributed equally to all effects at a rate equal to F_i which can be calculated as follows:

$$F_i = \frac{F}{n + j}, \quad j = \frac{n}{2} \quad (5)$$

The brine leaving the first effect enters into the second effect and so on up to the last effect n , and the brine from the last effect is rejected. The brine leaving the first, second and last effect can be calculated considering mass balance law as follows:

$$B_i = F_i - D_i \quad (6)$$

$$B_{i+1} = \sum_{i=1}^j (F_{i+1} - D_{i+1}) \quad (7)$$

$$B_n = 2 \cdot \sum_{i=1}^j (F_i - D_i) + \sum_{j+1}^n (F_{j+1} - D_{j+1}) \quad (8)$$

The salt mass conservation law is applied, assuming that the distillate is free of salt, to find brine salinity from the first, second and last effect as follows:

$$X_{bi} = \frac{F_i \cdot X_f}{(F_i - D_i)} \quad (9)$$

$$X_{bi+1} = \frac{F_{i+1} \cdot X_f}{\sum_{i=1}^j (F_{i+1} - D_{i+1})} \quad (10)$$

$$X_{bn} = \frac{F_n \cdot X_f}{2 \cdot \sum_{i=1}^j (F_i - D_i) + \sum_{j+1}^n (F_{j+1} - D_{j+1})} \quad (11)$$

The vapor generated in the first effect by boiling only and can be determined from the energy balance of the first effect as follows:

$$D_1 = \left[\frac{(D_s + D_r) \cdot (h_d - h_{fd})}{L_1} \right] - F_1 \cdot C \cdot \left(\frac{T_1 - T_{f1}}{L_1} \right) \quad (12)$$

The amount of vapor released from the second up to j can be expressed respectively as follows:

$$D_2 = (D_1 + D_r \cdot y - F_1 \cdot y) \cdot \frac{L_1}{L_2} + B_1 \cdot \frac{C \cdot \Delta T}{L_2} - F_2 \cdot C \cdot \frac{(T_2 - T_{f2})}{L_2} \quad (13)$$

$$D_j = [(D_{j-1} + \sum_{i=1}^{j-2} (D_i + D_r) \cdot y - (j-1) \cdot F_j \cdot y)] \cdot \frac{L_{j-1}}{L_j} + B_{j-1} \cdot \frac{C \cdot \Delta T}{L_j} - F_j \cdot C \cdot \frac{(T_j - T_{fj})}{L_j} \quad (14)$$

The vapor formed in the last effect of each ME-TVC unit D_j is divided into two streams; one is entrained by the thermo-compressor (D_r) and the other is directed to the MED unit.

$$D_j = D_r + D_f \quad (15)$$

The two streams of D_f are used as a heat source to operate low temperature multi effect distillation unit (LT-MED).

So, the vapor formed in first, second and last effect of this unit can be calculated as follows:

$$D_{j+1} = 2 \cdot D_f \cdot \frac{L_j}{L_{j+1}} + 2 \cdot B_j \cdot \frac{C \cdot \Delta T}{L_{j+1}} - F_{j+1} \cdot C \cdot \frac{(T_{j+1} - T_{fj+1})}{L_{j+1}} \quad (16)$$

$$D_{j+2} = \left(D_{j+1} + \sum_{i=1}^j (D_i + D_r) \cdot y - (j+n) \cdot F_{j+2} \cdot y \right) \cdot \frac{L_{j+1}}{L_{j+2}} + 2 \cdot B_{j+1} \cdot \frac{C \cdot \Delta T}{L_{j+2}} - F_{j+2} \cdot C \cdot \frac{(T_{j+2} - T_{fj+2})}{L_{j+2}} \quad (17)$$

$$D_n = [(D_{n-1} + \sum_{i=1}^{n-2} (D_i + D_r) \cdot y - (j+n-1) \cdot F_i \cdot y)] \cdot \frac{L_{n-1}}{L_n} + 2 \cdot B_{n-1} \cdot \frac{C \cdot \Delta T}{L_n} - F_i \cdot C \cdot \frac{(T_n - T_f)}{L_n} \quad (18)$$

The total distillate output from all effects is equal to

$$D = 2 \cdot \sum_{i=1}^j D_i + \sum_{j+1}^n D_{j+1}, \quad i = 1, 2, \dots, 3 \quad (19)$$

The energy balance of the thermo-compressor is used to calculate the enthalpy of the discharged steam as shown in equation (20),

$$h_d = \left(\frac{\left(\frac{D_s}{D_r} \right) \cdot h_s + h_{g(j)}}{1 + \left(\frac{D_s}{D_r} \right)} \right) \tag{20}$$

The most essential part in modeling the ME-TVC desalination system is to determine the ratio of motive steam to entrained vapor (D_s/D_r) in such thermo-compressors. An optimal ratio will improve the unit efficiency by reducing the amount of motive steam (Utomo et al., 2008). This ratio is a direct function of discharge pressure (P_d), motive steam pressure (P_s) and entrained vapor pressure (P_j) in terms of compression ratio (CR) and expansion ratio (ER) as follows (El-Dessouky & Ettouney, 2002; Al-Najem et al., 1997):

$$CR = \frac{P_d}{P_j} \tag{21}$$

$$ER = \frac{P_s}{P_j} \tag{22}$$

Several methods are available in the literature to evaluate entrainment ratios; most of these methods need lengthy computation procedures and use many correction factors (El-Dessouky & Ettouney, 2002). Two simple methods are used to evaluate this ratio in this chapter: (1) Power’s graphical data method (Al-Najem et al., 1997), (2) El-Dessouky and Ettouney’s semi-empirical model (El-Dessouky & Ettouney, 2002). Although Power’s method is a straightforward and the entrainment ratio can be extracted directly from Fig. 3

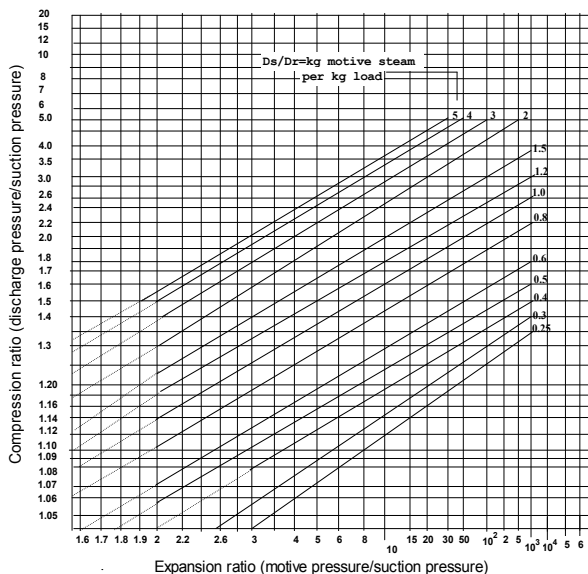

Fig. 3. Entrainment ratio for different compression and expansion ratios (Power, 1994)

in terms of compression ratio and expansion ratio, it is too difficult to use in such optimization and simulation models. The developed semi-empirical model in method 2 is applicable only if the motive fluid is steam and the entrained fluid is water vapor (Al-Juwayhel et al., 1997). The pressure and temperature correction factors were eliminated for simplicity and the model equation is modified as shown in equation (23); results were tested and compared with that obtained by Power’s graphical method for validity in the following range of motive pressure $3000 \geq P_s \geq 2000$ (kPa).

$$\left(\frac{D_s}{D_r}\right) = 0.235 \frac{(P_d)^{1.19}}{(P_j)^{1.04}} (ER)^{0.015} \tag{23}$$

4.2 Exergy balance

An exergy balance is also conducted to the system to find the exergy destruction (*I*) in each component; in thermo-compressor, effects, condenser and the leaving streams in kJ/kg according to the following equation:

$$I = T_o \cdot \Delta S = E_{in} - E_{out} \tag{24}$$

Where ΔS is the entropy increase, E_{in} is the input exergy and E_{out} is the output exergy.

4.2.1 Thermo-compressor

The exergy destruction in the thermo-compressor can be expressed as follows:

$$I_{ej} = D_s \cdot [(h_s - h_d) - T_o \cdot (S_s - S_d)] - D_r \cdot [(h_d - h_{gj}) - T_o \cdot (S_d - S_{gj})] \tag{25}$$

4.2.2 Effects

The exergy destruction in the first, second and last effect can be expressed respectively as follows;

$$I_{e1} = (D_s + D_r) \cdot [(h_d - h_{fd}) - T_o \cdot (S_d - S_{fd})] - D_1 \cdot L_1 \cdot \left(1 - \frac{T_o}{T_{v1}}\right) - F_1 \cdot C \cdot \left[(T_1 - T_{f1}) - T_o \cdot \ln\left(\frac{T_1}{T_{f1}}\right)\right] \tag{26}$$

$$I_{e2} = (D_1 + D_r \cdot y - F_2 \cdot y) \cdot L_1 \cdot \left(1 - \frac{T_o}{T_1}\right) + B_1 \cdot C \cdot \left[\Delta T - T_o \cdot \ln\left(\frac{T_1}{T_2}\right)\right] - D_2 \cdot L_2 \cdot \left(1 - \frac{T_o}{T_2}\right) - F_2 \cdot C \cdot \left[(T_2 - T_{f2}) - T_o \cdot \ln\left(\frac{T_2}{T_{f2}}\right)\right] \tag{27}$$

$$I_{en} = \left[D_{n-1} + \sum_{i=1}^{n-2} (D_i + D_r) \cdot y - (j + n - 1) F_i \cdot y \right] \cdot L_{n-1} \cdot \left(1 - \frac{T_o}{T_{n-1}}\right) + 2 \cdot B_{n-1} \cdot C \cdot \left[\Delta T - T_o \cdot \ln\left(\frac{T_{n-1}}{T_n}\right)\right] - D_n \cdot L_n \cdot \left(1 - \frac{T_o}{T_n}\right) - F_n \cdot C \cdot \left[(T_n - T_f) - T_o \cdot \ln\left(\frac{T_n}{T_f}\right)\right] \tag{28}$$

4.2.3 Condenser and leaving streams

The exergy destruction in the condenser, and in the leaving streams, D_r , D_f and B_n can be expressed using the following equations respectively:

$$I_c = D_n \cdot L_n \cdot \left(1 - \frac{T_o}{T_n}\right) - M_c \cdot C \cdot \left[(T_f - T_c) - T_o \cdot \ln\left(\frac{T_f}{T_c}\right) \right] \quad (29)$$

$$I_{Dr} = D_r \cdot C \cdot \left[(T_{vj} - T_c) - T_o \cdot \ln\left(\frac{T_{vj}}{T_c}\right) \right] \quad (30)$$

$$I_{Df} = D_f \cdot C \cdot \left[(T_{vj} - T_c) - T_o \cdot \ln\left(\frac{T_{vj}}{T_c}\right) \right] \quad (31)$$

$$I_{Bn} = D_n \cdot C \cdot \left[(T_n - T_c) - T_o \cdot \ln\left(\frac{T_n}{T_c}\right) \right] \quad (32)$$

4.3 Thermal load

The heat transfer area of an effect can be obtained from the latent heat of condensation (thermal load) of each effect as shown in equation (33), where ΔT_e is the temperature difference across the heat transfer surface.

$$Q = U_e \cdot A_e \cdot \Delta T_e \quad (33)$$

Therefore, the heat transfer area for the first, second and last effect can be obtained as follows:

$$A_{e1} = \frac{(D_s + D_r) \cdot [h_d - h_{fd}]}{U_{e1} \cdot (T_d - T_1)} \quad (34)$$

$$A_{e2} = \frac{(D_1 + D_r \cdot y - F_1 \cdot y) \cdot L_1}{U_{e2} \cdot (T_{v1} - T_2)} \quad (35)$$

$$A_n = \frac{[(D_{n-1} + \sum_{i=1}^{n-2} (D_i + D_r) \cdot y - (j + n - 1) \cdot F_i \cdot y] \cdot L_{n-1}}{U_{en} \cdot (T_{vn-1} - T_n)} \quad (36)$$

The overall heat transfer coefficient (U_e) depends mainly on the type, design and material of the tubes (El-Dessoukey et al., 2000), and for simplicity it can be calculated as follows (El-Dessouky & Ettouney, 2002):

$$U_{ei} = \frac{(1939.4 + 1.40562 \cdot T_i - 0.0207525 \cdot (T_i)^2 + 0.0023186 \cdot (T_i)^3)}{1000} \quad (37)$$

The cooling seawater flow rate can be obtained by applying the energy conservation law on the condenser as shown below:

$$M_c = \frac{D_f \cdot L_n}{C \cdot (T_f - T_c)} \quad (38)$$

The latent heat of condensation of the un-entrained vapor D_f flowing to the condenser is used to increase cooling seawater temperature to feed seawater temperature. The thermal load of the condenser is used to calculate the condenser heat transfer area as follows:

$$A_c = \frac{D_f \cdot L_n}{U_c \cdot (LMTD)_c} \quad (39)$$

The logarithmic mean temperature difference and the overall heat transfer coefficient of the condenser can be obtained from equations (40) and (41) respectively (El-Dessouky & Ettouney, 2002).

$$(LMTD)_c = \frac{(T_{vn} - T_f) - (T_{vn} - T_c)}{\ln \frac{(T_{vn} - T_f)}{(T_{vn} - T_c)}} \quad (40)$$

$$U_c = 1.7194 + 3.2063 \cdot 10^{-2} \cdot T_{vn} - 1.5971 \cdot 10^{-5} \cdot (T_{vn})^2 + 1.9918 \cdot 10^{-7} \cdot (T_{vn})^3 \quad (41)$$

Similarly, the heat transfer area of the feed heaters can be expressed as follow assuming that the overall heat transfer coefficient of the feed heaters are equals to that of the condenser.

$$A_{fi} = \frac{(i)F_i \cdot C \cdot \Delta T_f}{U_f \cdot (T_{fi} - T_{fi+1})} \cdot \ln \frac{(T_{vi} - T_{fi+1})}{(T_{vi} - T_{fi})}, \quad i = 1, 2, \dots, n-2 \quad (42)$$

4.4 System performance

The system performance of the ME-TVC model can be evaluated in terms of the following:

4.4.1 Gain output ratio, GOR

The gain output ratio is one of the most commonly performance used to evaluate thermal desalination processes. It is defined as the ratio of total distilled water produced (D) to the motive steam supplied (D_s).

$$GOR = \frac{D}{D_s} \quad (43)$$

4.4.2 Specific heat consumption, Q_d

This is one of the most important characteristics of thermal desalination systems. It is defined as the thermal energy consumed by the system to produce 1 kg of distilled water, where L_s is the motive steam latent heat in kJ/kg

$$Q_d = \frac{D_s \cdot L_s}{D} \quad (44)$$

4.4.3 Specific exergy consumption, A_d

The specific exergy consumption is one of the best methods used to evaluate the performance of the ME-TVC based on the Second Law of thermodynamics. It considers the quantity as well as the quality of the supplied motive steam. It is defined as the exergy consumed by the motive steam to produce 1 kg of distillate when the steam is supplied as saturated vapor and leaves as saturated liquid at ambient temperature equal to T_o , according to the following equation (Darwish et al., 2006):

$$A_d = \frac{D_s}{D} \cdot \left[(h_s - h_{fd}) - T_o \cdot (S_s - S_{fd}) \right] \quad (45)$$

where h_s , S_s are the inlet motive steam enthalpy and entropy at saturated vapor and h_{fd} , S_{fd} are that of the outlet condensate at saturated liquid.

4.4.4 Specific heat transfer area, A_t

The specific total heat transfer area is equal to the sum of the effect, feed heaters and the condenser heat transfer areas per total distillate product ($\text{m}^2/\text{kg/s}$).

$$\frac{At_d}{D} = 2 \cdot \sum_{i=1}^j \frac{A_{ei}}{D_i} + \sum_{j+1}^n \frac{A_{ei}}{D_i} + \sum_{i=1}^{n-2} \frac{A_{fi}}{D_i} + \frac{A_c}{D} \quad (46)$$

4.4.5 Specific exergy destruction, I_t

This term shows the total exergy destruction due to heat transfer and in the thermo-compressor, evaporators, condenser and the leaving streams per unit of distillate water.

$$I_t = \sum \frac{I_i}{D} \quad (47)$$

where I_i is the exergy destruction in each component in kJ/kg .

4.5 Model validity

Engineering Equation Solver (EES) software is used to evaluate the ME-TVC system performance. The validity of the model was tested against some available data of three commercial units having different unit capacities: ALBA in Bahrain (2.4 MIGD), Umm Al-Nar in UAE (3.5 MIGD) and Al-Jubail in KSA (6.5 MIGD). The results showed good agreements as shown in Table 2.

It is also cleared from Table 2 that the available data of Al-Jubail unit is limited in the literature. Hence, the developed mathematical model is used to predict the missing values in order to evaluate the system performance of this plant.

Desalination Plant	ALBA		UMM AI-NAR		AL-JUBAIL	
Number of effects, n	4		6		8	
<i>Operating and Design Parameters</i>	Model	Actual	Model	Actual	Model	Actual
Motive pressure, bar	21	21	2.8	2.8	2.7	2.7
Top brine temperature, °C	63	63	63	62	63	NA
Minimum brine temperature, °C	48	48	44	43	42	NA
Feed sea water temperature, °C	43	43	40	40	40	NA
Motive steam flow rate, kg/s	8.5 × 2	8.3 × 2	11×2	10.65×2	15.5×2	NA
Temperature drop per effect, °C	5	5	3.8	3.8	3	NA
<i>Thermo-compressor Design</i>						
Compression ratio	1.57	NA	1.7	NA	1.75	NA
Expansion ratio	120	NA	18.11	NA	18.7	NA
Motive to entrained vapor ratio	0.58	NA	0.885	NA	0.98	NA
<i>System Performance</i>						
Distillate production, kg/s	123	127	184.2	184.38	340.4	342.22
Gain output ratio	7.23	7.5	8.37	8.6	10.9	9.8
Specific heat consumption, kJ/kg	348.4	NA	292.1	287.5	223	NA
Specific exergy consumption, kJ/kg	127.7	NA	74.6	NA	56.44	NA
Specific heat transfer area, m ² /kg/s	244.2	NA	335.6	310	452.2	NA
Specific exergy destruction, kJ/kg/s	94.65	NA	54.24	NA	41.16	NA

Table 2. Mathematical model calculations against some commercial plants.

5. Sensitivity analysis

The new trend of combining ME-TVC desalination system with a conventional Multi effect distillation (MED) unit has been used lately in different large projects and has been also discussed in a few published works (Al-Habshi, 2002), (Darwish & Alsairafi, 2004) and (Bin Amer, 2009). Thus, a sensitivity analysis will be presented in this section to investigate the system performance variations of Al-Jubail ME-TVC unit. This project belongs to Marafiq Company and it is currently considered as the largest ME-TVC desalination plants in the world, it consists of 27 units each of 6.5 MIGD as shown in Fig.4.

The available data of this unit in the literature are: the gain output ratio, number of effect, motive pressure and the unit capacity. These data are used along with the model equations to evaluate the system performance of the plant.

Fig.5. shows the effect of motive steam flow rate on the vapor formed in each effect of this unit, at $T_1 = 63$ °C and $\Delta T = 3$ °C. The total distillate production can be controlled by adjusting the motive steam flow rate. The reason is when the motive steam flow rate increases the entrained vapor also increases for constant entrainment ratio (D_s/D_r), this will lead to generate more vapor and consequently more distillate water.

The variation of the gain output ratio and the distillate production as a function of top brine temperature is shown in Fig.6. It is cleared that as the top brine temperature increases the distillate output production decreases and consequently gain output ratio decreases. This is

Fig. 4. Schematic diagram similar to Al-Jubail (MARAFIQ) ME-TVC unit, 6.5 MIGD.

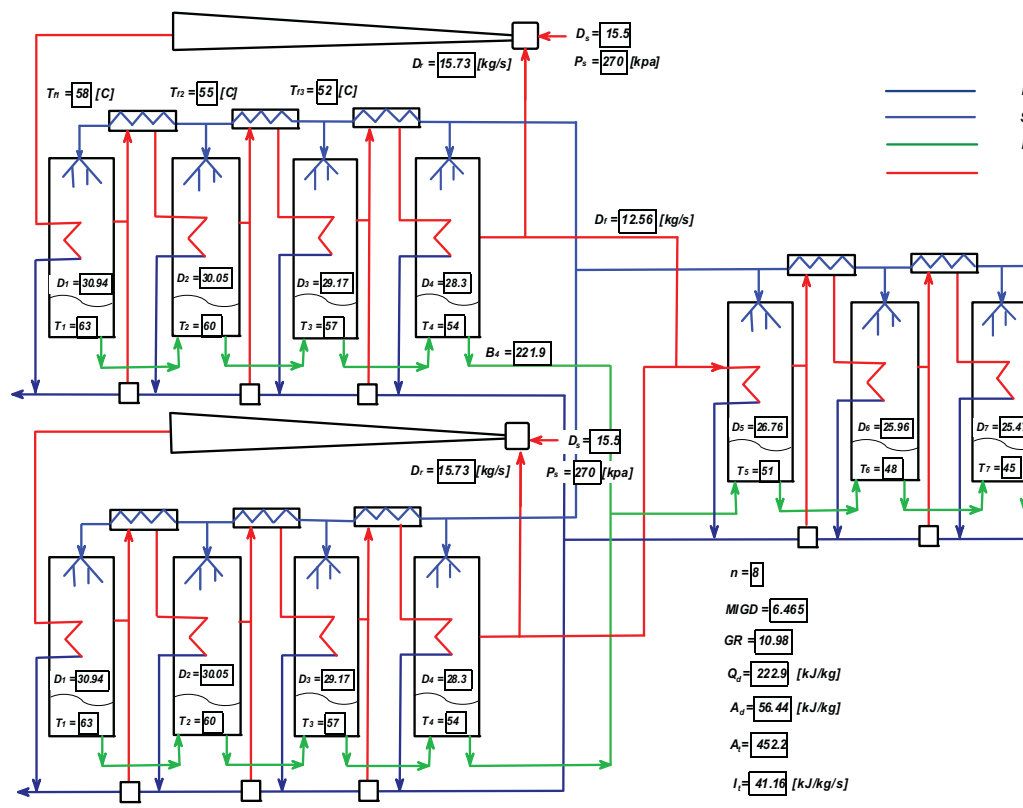

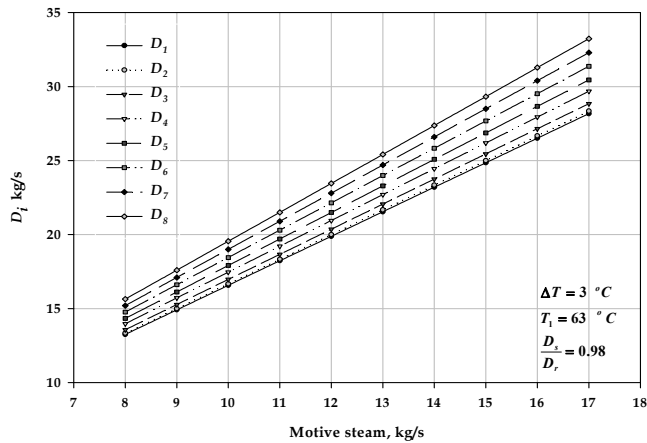

Fig. 5. The effect of motive steam on the distillate production from the effects.

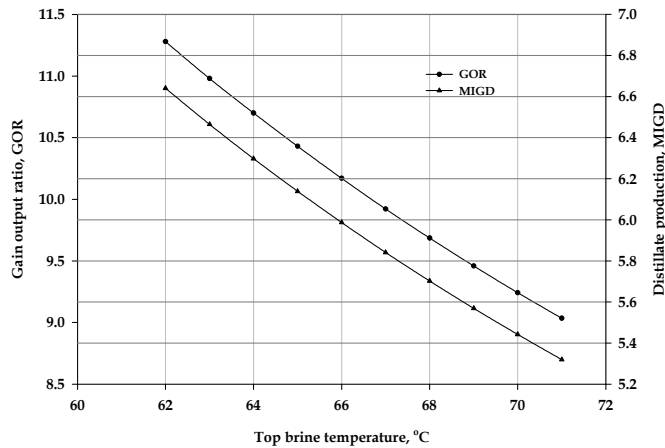

Fig. 6. The effect of top brine temperature on the distillate production and gain output ratio.

because more amount of sensible heating is required to increase the feed seawater temperature to higher boiling temperatures. Additionally, the latent heat of the vapor decreases at higher temperatures.

The direct dependence of the top brine temperature on the specific heat consumption and the specific exergy consumption are shown in Fig. 7. Both of them increase linearly as the top brine temperature increases, because higher top brine temperature leads to higher vapor pressure and consequently larger amount of motive steam is needed to compress the vapor at higher pressures. Fig.8. demonstrates the variations of the specific heat transfer area as a function of temperature difference per effect at different top brine temperatures. The increase in the specific heat transfer area is more pronounced at lower temperature difference per effect than at lower top brine temperatures. So, a high overall heat transfer coefficient is needed to give a small temperature difference at reasonable heat transfer area.

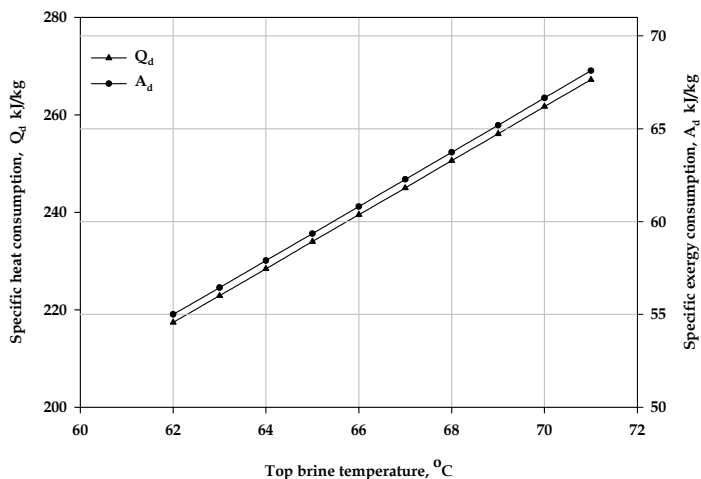

Fig. 7. The effect of top brine temperature on the specific heat consumption and specific exergy consumption.

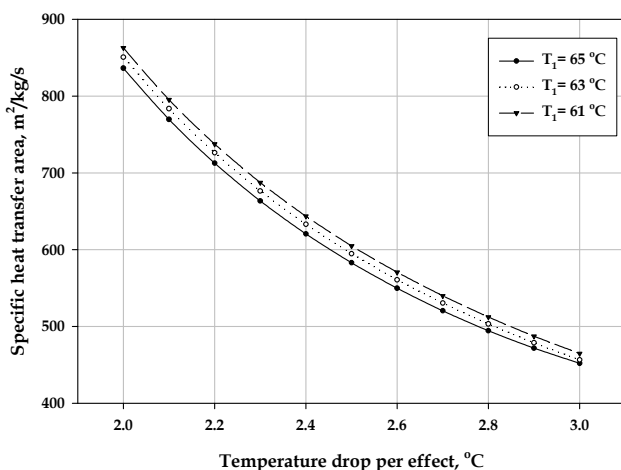

Fig. 8. The effect of temperature drop per effect on the specific heat transfer area.

The exergy analysis is also used to identify the impact of the top brine temperature on the specific exergy destruction for different ME-TVC units as shown in Fig.9. It shows that as the top brine temperature increases, the specific exergy destruction of ALBA, Umm Al-Nar and Al-Jubail plants are increased. It shows also that Al-jubail unit has the lowest values compared to other units. Fig.10 gives detail values of exergy destruction in different components of Al-Jubail units, while Fig.11 pinpoints that thermo-compressor and the effects are the main sources of exergy destruction. On the other hand, the first effect of this unit was found to be responsible for about 31% of the total effects exergy destruction compared to 46% in ALBA and 36% in Umm Al-Nar as shown in Fig.12.

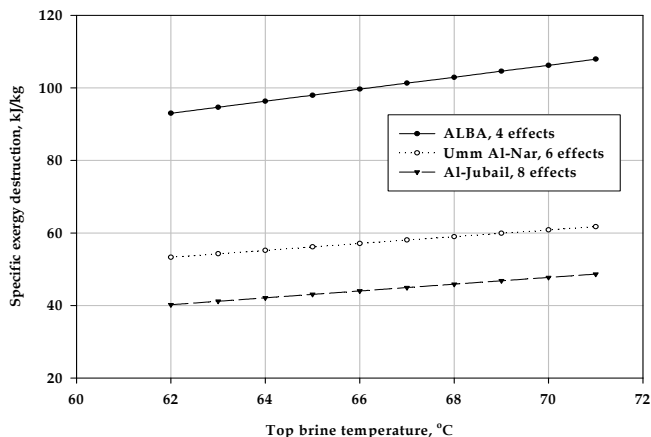

Fig. 9. The effect of top brine temperature on the specific exergy destruction for different units.

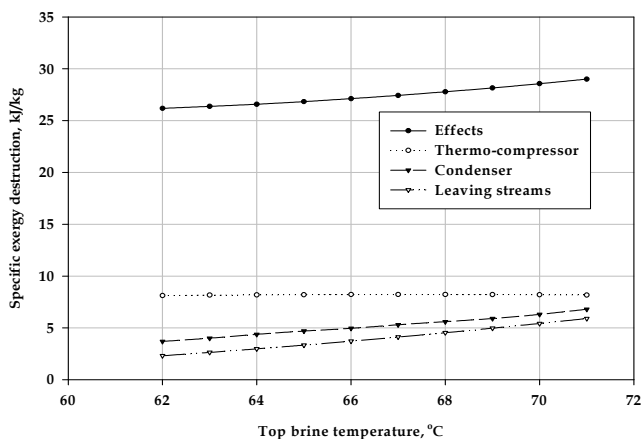

Fig. 10. The effect of top brine temperature on the specific exergy destruction in different components of Al-Jubail ME-TVC unit.

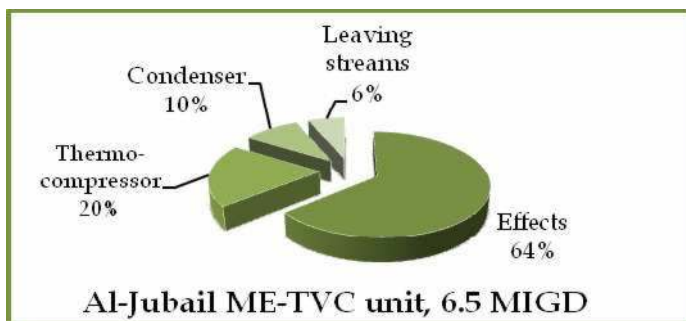

Fig. 11. The exergy destruction in the effects, thermo-compressor, condenser and leaving streams of Al-Jubail unit.

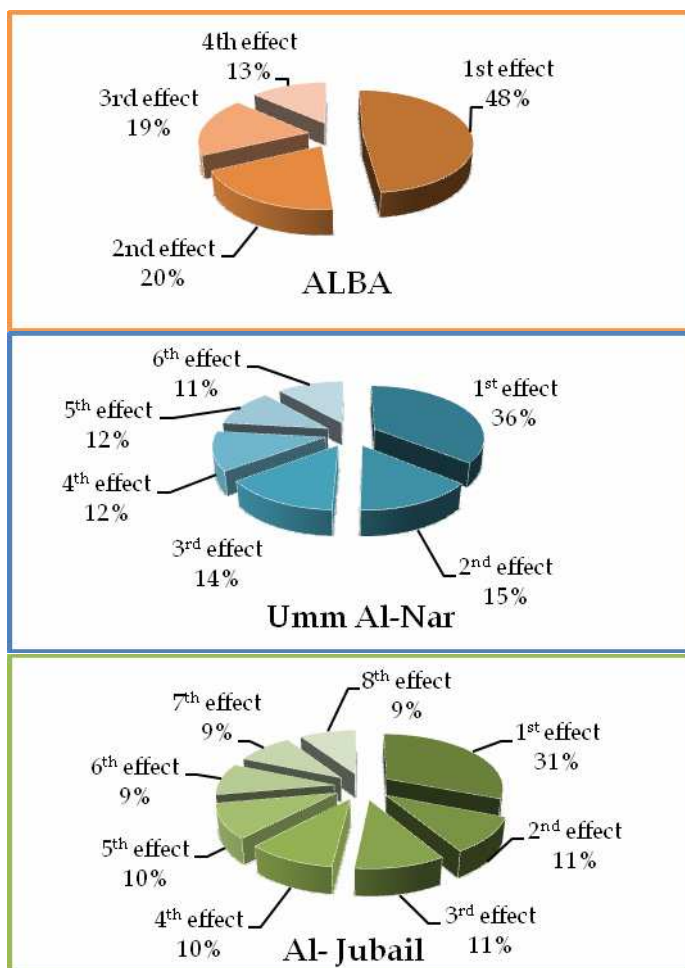

Fig. 12. The exergy destruction in the effects of ALBA, Umm Al-Nar and Al-Jubail units.

6. Development of ME-TVC desalination system.

The first ME-TVC desalination unit of 1 MIGD capacity was commissioned in 1991 in the UAE. It has four effects with a gain output ratio close to 8. A boiler was used to supply steam at high motive pressure of 25 bars (Michels, 1993). The next unit capacity was 2 MIGD which started up in 1995 in Sicily (Italy). It consisted of four identical units; each had 12 effects, with a gain output ratio of 16. The steam was supplied from two boilers at 45 bars to the plant (Temstet, 1996). More units of 1, 1.5 and 2 MIGD were also ordered and commissioned in UAE between 1996 -1999 due to excellent performance of the previous projects (Sommariva, 2001).

The trend of combining ME-TVC desalination system with multi-effect distillation (MED) allowed the unit capacity to increase into a considerable size with less number of effects and at low top brine temperature.

The first desalination project of this type was commissioned in 1999 by SIDEM Company in Aluminum of Bahrain (ALBA). A heat recovery boiler is used to supply high motive steam of 21 bars into four identical units of 2.4 MIGD. Each unit had four effects with a gain output ratio close to 8 (Darwish & Alsairafi, 2004). The next range in size was achieved is 3.5 MIGD in 2000. Two units of this size were installed in Umm Nar; each unit had six effects with a gain output ratio close to 8. The steam was extracted from a steam turbine at 2.8 bars to supply two thermo-compressors in each unit (Al-Habshi, 2002). This project is followed by Al-Taweelah A₁ plant, which was commissioned in 2002 as the largest ME-TVC project in the world at that time. It consists of 14 units; each of 3.8 MIGD. The next unit size that commissioned was in Layyah with a nominal capacity of 5 MIGD (Michels, 2001). The unit size jump to 8 MIGD in 2005 where two units were built in UAE. SIDEM has been also selected to build the largest hybrid plant to date in Fujairah (UAE) which has used two desalination technologies (ME-TVC and SWRO) to produce 130 MIGD as shown in Table 3.

Plant Details	ALBA	Umm Al-NAR	Al-JUBAIL	Al-Fujairah
Country	Bahrain	UAE	KSA	UAE
Year of commission	1999	2000	2007	2008
Source of steam/Arrangement	Boiler	CG-ST/HRSG	CG-ST/HRSG	CG-ST/HRSG
Type of fuel	Diesel oil	Natural gas	Natural gas	Natural gas
Power Capacity, MW	-	1700	2700	2000
Desalination technology	ME-TVC	ME-TVC	ME-TVC	ME-TVC/RO
Unit capacity, MIGD	2.4	3.5	6.5	8.5/RO
Number of units	4	2	27	12/RO
Total capacity, MIGD	9.6	7	176	100+30
Number of effects	4	6	8	10
Water cost, US \$/m ³	NA	NA	0.827	0.60

Table 3. Specifications of different ME-TVC desalination units.

6.1 New large projects

This technology is starting to gain more market shares now, in most of the GCC countries for large-scale desalination projects like in Bahrain, Saudi Arabia, and Qatar.

6.1.1 Al-Hidd.

Al-Hidd power and water plant located in northern of Bahrain, consists of three gas fired combined cycle units that produces around 1000 MW. A low motive steam pressure of 2.7 bars is used to feed 10 ME-TVC units, each of 6 MIGD and 9 gain output ratio.

6.1.2 Al-Jubail.

The Independent Water and Power Project (IWPP) MARAFIQ became one of the largest integrated power and desalination plant projects in the world under a BOOT scheme. The

project located near Al-Jubail City, north east of Kingdom of Saudi Arabia. It consists of a combined cycle power plant produces 2750 MW along with the world's largest ME-TVC desalination plants of 176 MIGD capacity (27 units \times 6.5 MIGD). The units are driven by low motive steam pressure of 2.7 bars. Each unit consisting of 8 effects with gain output ratio around 10.

6.1.3 Ras Laffan.

Ras Laffan is the largest power and water plant in Qatar so far. It will provide the city with 2730 MW electricity and 63 MIGD desalinated water. The power plant consists of eight gas turbines each in conjunction with heat recovery steam generator (HRSG). The high pressure steam enters four condensing steam turbines. A heating steam of 3.2 bars is used to operate 10 ME-TVC units, each of 6.3 MIGD and gain output ratio of 11.1.

6.2 New design and material selection.

Most of the construction materials used in ALBA and Umm Al-Nar desalination plants are almost the same as shown in Table 4. Stainless steel 316L was used for evaporator, condenser and pre-heaters shells, tube-plates, water boxes, spray nozzles and thermo-compressor. Aluminum brass was selected for the tube bundles of the evaporator, except the top rows which were made of titanium in order to prevent erosion corrosion, as water is sprayed from nozzles with high velocities at the upper tubes of the tube bundles (Wangnick, 2004).

Plant	ALBA	Umm Al-Nar	New projects
Evaporator vessel	Cylindrical	Cylindrical	Rectangular
- Shell in contact with seawater	SS 316L	SS 316L	Duplex SS
- Shell in contact with vapor	SS 316L	SS 316L	Duplex SS
- Vapor and distillate boxes	SS 316L	SS 316L	Duplex SS
Heat tube bundles	Titanium	Titanium	Titanium
- Tubes (top rows)	Aluminum	Aluminum	Aluminum
- Tubes (other rows)	brass	brass	brass
- Tube-plates	SS 316L	SS 316L	SS 316L
Demisters	SS 316	SS 316-03	polypropylene
Spray nozzles	SS 316L	SS 316L	SS 316L
Condenser & Pre-heaters	SS 316L	SS 316L	Duplex SS
- Shell & tube-plates	Titanium	Titanium	Titanium
- Tubes	SS 316L	SS 316L	SS 316L
- Water boxes			
Thermo-compressor	NA	SS 316L	Duplex SS

Table 4. Construction materials of the ME-TVC desalination plants.

The new ME-TVC units have rectangular vessel evaporators instead of circular ones as shown in Fig. 13, which gives much more freedom of design (Wangnick, 2004). Additionally, the Duplex stainless steel is also used in these plants instead of 316L Stainless steel as it has better corrosion resistance, higher strength, longer service life as well as lower weight and less market price. (Olsson et al., 2007).



(a) Circular vessel evaporator.



(b) Rectangular vessel evaporator.

Fig. 13. Two types of vessel evaporator used in different ME-TVC units.

In 2005, the first large capacity unit of 8 MIGD was commissioned in UAE, which used the duplex grades stainless steel. It was then used for Al-Hidd plant in Bahrain in 2006 followed by eight units in Libya in 2007, 27 units in Kingdom of Saudi Arabia in 2008 and 12 units in Al-Fujairah in 2009 (Peultier et al., 2009).

6.3 System performance development

The rapid developments in the performance criteria of the ME-TVC during the last ten years can be also observed clearly from Tables 1, 2, 3 and 4 under the following points:

1. This technology is gaining more market shares recently in Bahrain, Saudi Arabia and Qatar in large scale desalination projects with a total installed capacity of 60 MIGD, 176 MIGD and 63 MIGD, respectively.
2. Although the unit size capacities of these desalination projects were almost around six MIGD, their gain output ratios increased gradually to 8.9, 9.8 and 11.1 during 2006, 2007 and 2009 respectively, as shown in Fig. 14.
3. Duplex stainless steels are used in manufacturing the new units instead of 316L stainless steel which have better resistance to corrosion, less costly due to lower contents of nickel and molybdenum, (Olsson et al., 2007).
4. The manufacturer tried to increase the number of effects gradually (4, 6, 8, etc.) in order to increase the size of the units in a compact design.
5. The new generation of large ME-TVC units with high gain output ratio working in conjunction with reverse osmosis as in Al-Fujairah has dramatically decreased the desalinated water production cost as shown in Fig. 15.

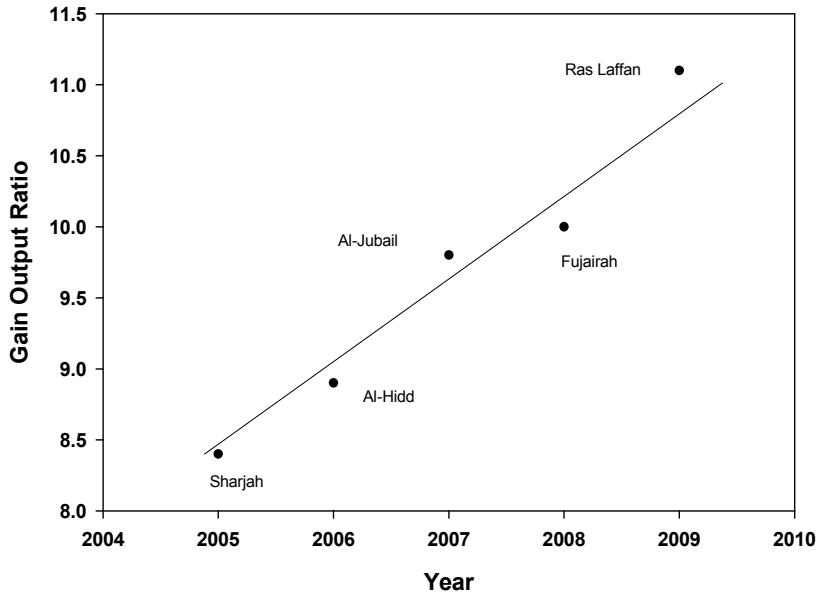

Fig. 14. The increase in the gain output ratio of new ME- TVC projects

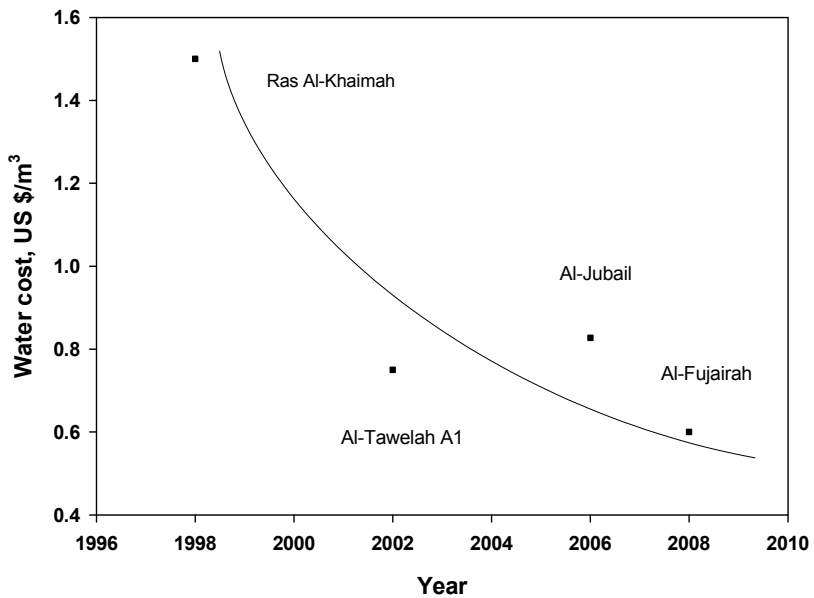

Fig. 15. The drastic decrease in the water cost in the UAE in the last decade.

7. Optimization of ME-TVC desalination system

The schematic diagram consists of n number of effects varying from 4 to 16. In any mathematical optimization problem, the objective function, design variables and constrains should be specified in order to formulate the problem properly and to select the appropriate optimization method (Bejan et al., 1996). The general statement of the optimization problem is in the following form:

$$\begin{aligned} \text{Find} \quad & \chi = \{\chi_1, \chi_2, \dots, \chi_N\} \\ \text{To Max} \quad & f(\chi) = f(\chi_1, \chi_2, \dots, \chi_N) \\ \text{Subject to} \quad & g_j(\chi) \leq 0, j=1, 2, \dots, m \end{aligned}$$

Where N is the number of design variables and m is the number of constraints.

7.1 Optimization approaches

The objective of this optimization work is to find the optimum operating and design conditions of ME-TVC desalination unit for different number of effects to maximize the gain output ratio (GOR). MATLAB algorithm solution is used to solve the mathematical model equations by two approaches: (1) Smart Exhaustive Search Method (SESM), which is used for linear and non-linear programming model, based on "for-loops" algorithm, and (2) Sequential Quadratic Programming (SQP), which is a versatile method for solving non-linear constrained optimization problem, based on finding a feasible solution and then start optimization.

The motive steam flow rate is considered to be available at 7 kg/s, directly from a boiler at 25 bars. The cooling and sea seawater temperatures are 30 °C and 40 °C respectively.

The main variables that affect the gain output ratio for a particular number of effects and which can be modified by optimization process are top brine temperature, entrainment ratio and temperature difference per effect (Alasfour et al., 2005).

A set of lower and upper values of those variables were selected as constraints from literatures. Since most ME-TVC plants operate with low top brine temperature (TBT) (not exceeding 75°C) so as to avoid scale formation and corrosion troubles (Al-shammiri & Safar, 1999). The TBT of 76 °C is set here for the upper limit while the lower limit is assumed to be 56 °C (Fisher et al., 1985). The discharged steam temperature T_d is considered to be the hot end temperature of the unit and it is limited by the compression ratio of the steam jet ejector, usually 3 to 5°C above the allowable top brine temperature. In contrast, the last brine temperature, T_n is kept at least 2°C greater than the feed water temperature, T_f (El-Dessouky & Ettouney, 2002), which is assumed to be 10°C greater than the cold end temperature of the model, T_c .

The minimum temperature drop per effect including all thermodynamic losses is close to 1.5 - 2°C (Ophir & Lokiec, 2005) and the maximum temperature drop per effect is set as an upper limit equal to 5°C, and making it higher than this value leads to high top brine temperature and consequently high operating cost (Michels, 2001).

The constraints of entrainment and compression ratios are $\frac{D_s}{D_r} \leq 4$ and $4 \geq CR \geq 1.81$

respectively (El-Dessouky et al., 2000). The problem can be formulated in a standard design optimization model as shown in Fig. 16.

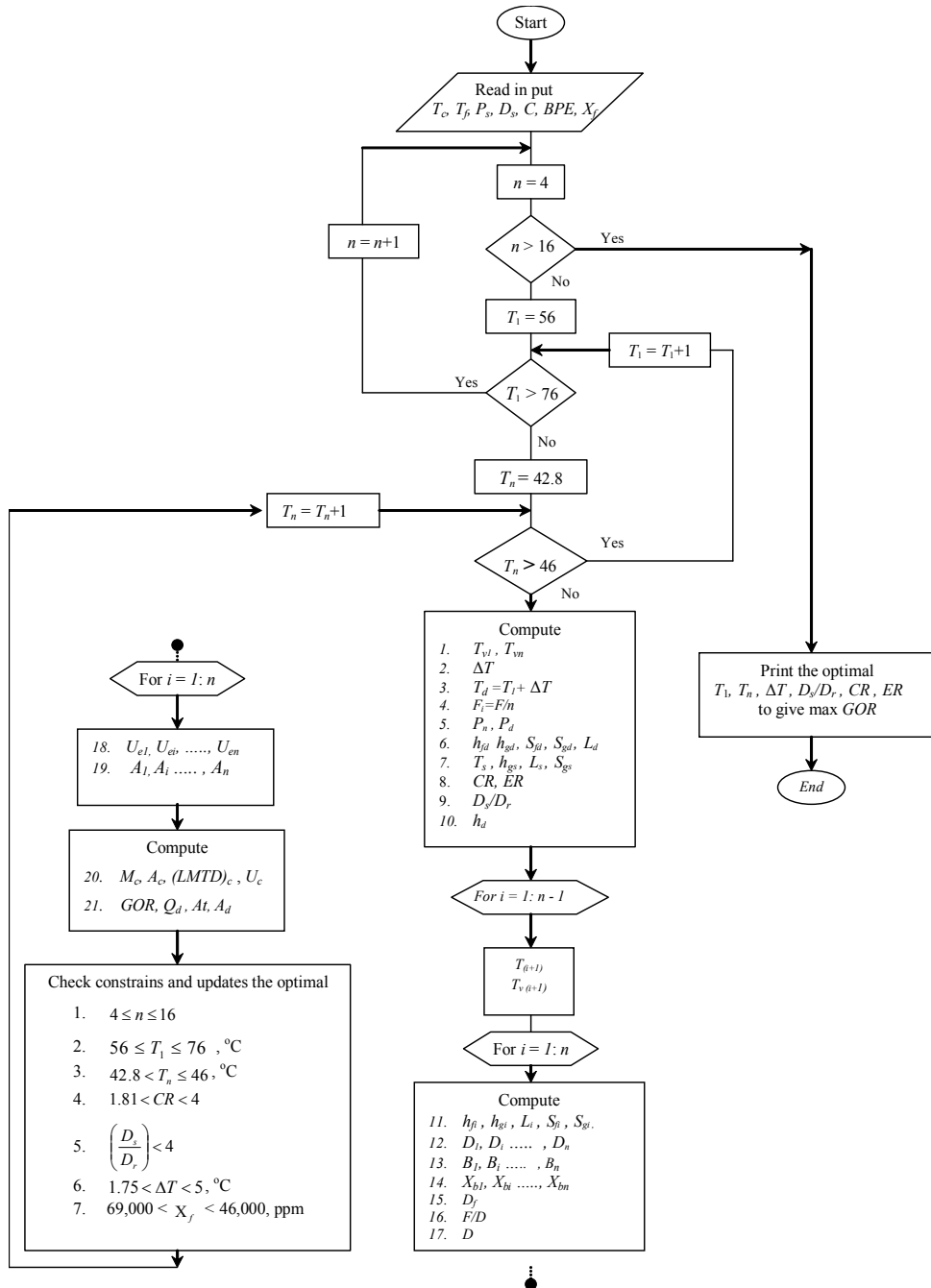

Fig. 16. Solution algorithm of the optimization problem.

7.2 Results and discussion

The optimal computed results of the mathematical optimization problem are displayed below in Table 5.

<i>n</i>	<i>Temperature, °C</i>			<i>Ejector Design</i>			<i>System performance</i>			<i>GOR</i>	
	<i>T₁</i>	<i>T_n</i>	ΔT	<i>CR</i>	<i>ER</i>	<i>D_s/D_r</i>	<i>Q_d, kJ/kg</i>	<i>A_d, kJ/kg</i>	<i>At_d, m²/kg/s</i>	<i>SESM</i>	<i>SQP</i>
4	56	45.8	3.4	1.95	263	0.792	312.8	116.9	450.8	8.18	8.24
5	56	45.8	2.55	1.87	263	0.756	249.6	93.15	699.8	10.27	10.26
6	56	45.8	2.04	1.82	263	0.734	240.1	89.5	947.8	10.67	11.72
7	56	45.3	1.78	1.85	270	0.744	216.3	80.67	1150	11.87	13.28
8	56	43.3	1.81	2	300	0.831	202	75.3	1016.8	12.7	14.57
9	57	42.8	1.77	2.2	307	0.902	187	69.82	982	13.7	15.8
10	59	42.8	1.8	2.43	307	1	174.8	65.42	879	14.61	16.93
11	60.5	42.8	1.77	2.6	307	1.01	161.5	60.5	851.5	15.78	18.1
12	62.5	42.8	1.79	2.85	307	1.22	150	56.36	786.84	16.94	19.41
13	64	42.8	1.76	3	307	1.32	138.3	52	776.5	18.32	20.6
14	66	42.8	1.78	3.33	307	1.47	128.1	48.34	744.6	19.71	21.93
15	67.5	42.8	1.76	3.56	307	1.58	118.2	44.67	752.6	21.31	23.3
16	69.5	42.8	1.78	3.88	307	1.76	109.5	41.47	748.47	22.93	24.74
Time, s										8.89	0.109

Table 5. Optimal operating and design conditions for different number of effects.

In the light of the results shown in Table 5 the following facts can be reported: -

1. The optimal results of GOR obtained by SQP method are close but better than that obtained by SESM and the corresponding total execution time is also less (0.109 sec compared to 8.89 sec, CPU time).
2. The maximum gain output ratio is varied between "8.2 to 24.7" for 4-effects and 16-effects and the optimal top brine temperature varies between 56 to 69.5°C respectively as shown in Fig.17.
3. ME-TVC system can operate at top brine temperature below 60°C with a maximum gain output ratio of 16.9 for 10 effects.

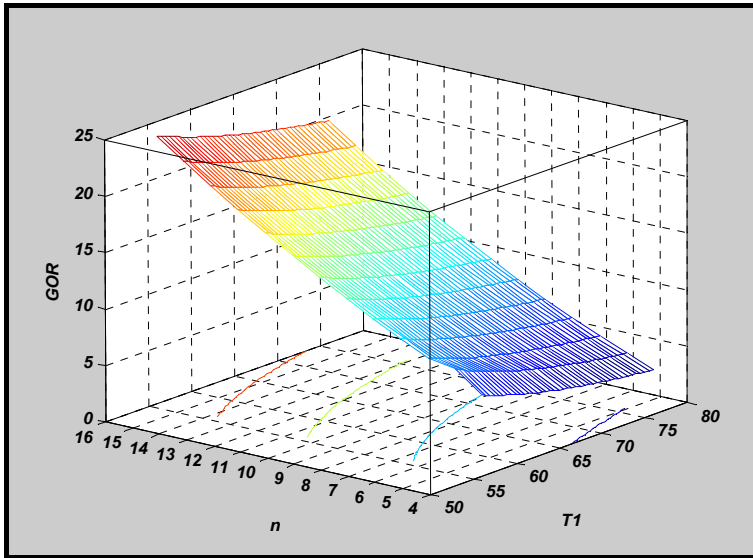

Fig. 17. The impact of top brine temperature and the number of effects on the gain output ratio.

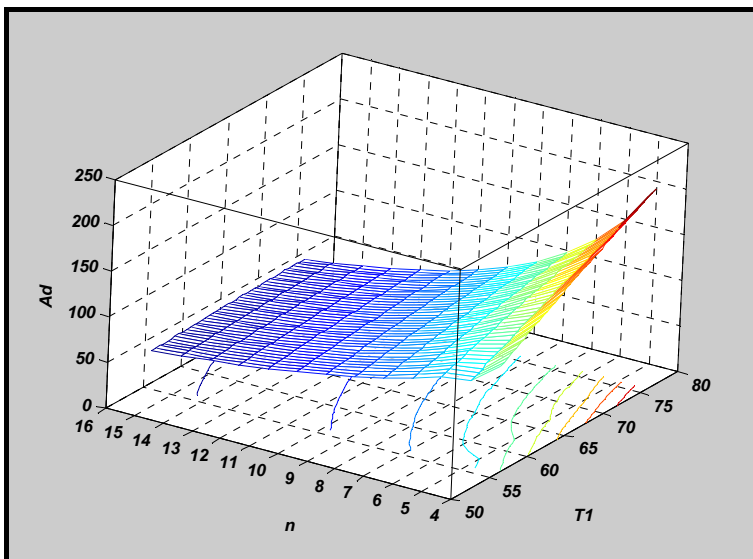

Fig. 18. The impact of top brine temperature and the number of effects on the specific exergy consumption.

4. A maximum gain output ratio of 15.8 can be achieved by ME-TVC, which is close to that of an existing plant (in Sicily), but with low motive pressure (25 bar compared to 45 bar), less number of effects (9 effects compared to 12) and less top brine temperature (57°C compared to 63°C).
5. The optimal entrainment ratios (D_s/D_r) vary from 0.79 for 4 effects to 1.76 for 16 effects.
6. It is clear that as the number of effects increases the gain output ratio, compression ratio and entrainment ratio increases, while the specific exergy consumption decreases as shown in Fig. 18.

8. Conclusion

- This chapter outlines the performance developments in multi-effect thermal vapor compression systems during the last decade in view of some commercial units which were built by SIDEM Company. The new trend of combining ME-TVC desalination system with a conventional Multi effect distillation (MED) unit has been used lately in several large projects. This trend provides an approach to increase the unit capacity with a more compact design.
- Most of the new ME-TVC units are commonly operated with large combined cycle power plants (CC-PP) which are characterized by high efficiency in order to reduce the power and water costs. Al-Fujairah is an ideal example of a large hybrid desalination project which led to considerable reduction in the desalinated water cost.
- Greater understanding of the behavior of the material at different operating conditions led the manufacturer to use Duplex grades of stainless steel in different parts of the new units instead of conventional material (316L). Titanium is being selected also for the tube bundles instead of aluminum brass.
- Exergy analysis shows that the specific exergy destruction in ALBA unit (94.65 kJ/kg) is almost twice that in Umm Al-Nar and Al-Jubail units (54.24 kJ/kg and 41.16 kJ/kg respectively) because high motive pressure of 21 bars is used in ALBA compared to low motive pressure of 2.8 bars in other units. The analysis indicates that thermo-compressor and the effects are the main sources of exergy destruction in these units. On the other hand, the first effect of this unit was found to be responsible for about 31% of the total effects exergy destruction compared to 46% in ALBA and 36% in Umm Al-Nar. The specific exergy destruction can be reduced by increasing the number of effects as well as working at lower top brine temperatures.
- The manufacturer has tried to improve the new ME-TVC desalination system projects based on their experience in the previous projects. Further developments can be achieved by technical optimization in order to reduce the desalinated water cost.
- A MATLAB algorithm was developed and used to solve a mathematical model optimization problem, where different numbers of effects were tested to maximize the gain output ratio using: (1) Smart Exhaustive Search Method and (2) Sequential Quadratic Programming. The maximum gain output ratio varied between 8.24 to 24.74 for 4 and 16 effects with an optimal top brine temperature ranging between 56 to 69.5°C and reasonable specific heat transfer area. The optimal ranges of compression and entrainment ratios were between 1.82 to 3.88 and 0.734 to 1.76, respectively. The

- optimal results of GOR obtained by SQP method are close but better than that obtained by SESM and the corresponding total execution time is also less (0.109 sec compared to 8.89 sec, CPU time).
- To conduct a complete and successful optimization in a multi effect thermal vapor compression desalination system, exergo-economic analysis must be understood to know the behavior of the quality of the energy from a cost point of view and this chapter can be an introduction to exergo-economic optimization design in future work.

9. References

- Alasfour, F.; Darwish, M. & Bin Amer, A. (2005). Thermal analysis of ME- TVC + MEE desalination system. *Desalination*, Vol. 174 (2005) 39-61.
- AL-Habshi, S. (2002). Simulation and economic study of the MED-TVC units at Umm Al-Nar desalination plant. *Thesis report*, (2002) UAE.
- Al-Juwayhel, F.; El-Dessouky, H. & Ettouney, H. (1997). Analysis of single-effect evaporator desalination systems combined with vapor compression heat pumps. *Desalination*, Vol. 114 (1997) 253-275.
- Al-Najem, N.; Darwish, M. & Youssef, F. (1997). Thermo-vapor compression desalination: energy and availability analysis of single and multi-effect systems. *Desalination*, Vol. 110 (1997) 223 – 238.
- Al-Shammiri, M. & Safar, M. (1999). Multi-effect desalination plants: state of the art. *Desalination*, Vol. 126 (1999) 45-59.
- Ashour, M. (2002) Steady state analysis of the Tripoli West LT-HT-MED plant. *Desalination*, Vol. 152 (2002) 191-194.
- Bejan, A.; Michael, J. & George, T. (1996). *Thermal design and optimization*, John Wiley & Sons, 0471584673, New York.
- Bin Amer, A. (2009). Development and optimization of ME-TVC desalination system. *Desalination*, Vol. 249 (2009) 1315-1331.
- Choi, H.; Lee, T.; Kim, Y. & Song, S. (2005). Performance improvement of multiple-effect distiller with thermal vapor compression system by exergy analysis. *Desalination*, Vol. 182 (2005) 239-249.
- Cipollina, A.; Micale, G. & Rizzuit, L. (2005). A critical assessment of desalination operation in Sicily. *Desalination*, Vol. 182 (2005) 1-12.
- Darwish, M. & Alsairafi, A. (2004). Technical comparison between TVC/MEB and MSF. *Desalination*, Vol. 170 (2004) 223-239.
- Darwish, M.; Alasfour, F. & Al-Najem, N. (2002). Energy consumption in equivalent work by different desalting methods case study for Kuwait. *Desalination*, Vol. 152 (2000) 83-92.
- Darwish, M.; Al-Juwayhel, F. & Abdurrahim, H. (2006). Multi-effect boiling systems from an energy viewpoint. *Desalination*, Vol. 194 (2006) 22-39.
- El-Dessouky, H. & Ettouney, H. (1999). Multiple-effect evaporation desalination systems: thermal analysis. *Desalination*, Vol. 125 (1999) 259-276.

- El-Dessouky, H.; Ettouney, H. & Al-Juwayhel, F. (2000). Multiple effect evaporation- vapor compression desalination processes. *Trans IChemE*, Vol. 78, Part a, (May 2000) 662-676.
- El-Dessouky, H. & Ettouney, H. (2002). *Fundamental of salt-water desalination*, Elsevier Science, 0444508104, Amsterdam.
- Fisher, U.; Aviram, A. & Gendel, A. (1985). Ashdod multi-effect low temperature desalination plant report on year of operation. *Desalination*, Vol. 55 (1985) 13-32.
- Hamed, O.; Zamamiri, A.; Aly, S. & Iior, N. (1996). Thermal performance and exergy analysis of a thermal vapor compression desalination system. *Energy Conversion Mgmt*, Vol. 37 (1996) 379-387.
- Michels, T. (1993). Recent achievements of low temperature multiple effect desalination in the western areas of Abu Dhabi, UAE. *Desalination*, Vol. 93 (1993) 111-118.
- Michels, T. The modern MED pursuing its way in the Gulf Region. *European Desalination Society, Newsletter*, 11 January 2001.
- Olsson, J. & Snis, M. (2006). Duplex- A new generation of stainless steel for desalination plants. *Proceeding of EDS congress on desalination strategies in South Mediterranean Countries*, Montpellier, 2006.
- Ophir, A. & Lokiec, F. (2005). Advanced MED process for most economical sea water desalination. *Desalination*, Vol. 182 (2005) 187-198.
- Peultier, J.; Baudu, V.; Boillot, P. & Gagnepain, J. (2009). New trends in selection of metallic material for desalination industry. *Proceeding of IDA world congress on desalination and water reuse*. Dubai, November, 2009, UAE.
- Power, R. (1994). *Steam Jet Ejectors for the Process Industries*, McGraw-Hill, 0070506183, NewYork.
- Reddy, K. & Ghaffour, N. (2007). Overview of the cost of desalinated water and costing methodologies. *Desalination*, 205 (2007) 340-353.
- Sayyaadi, H & Saffaria, A. (2010). Thermo-economic optimization of multi effect distillation desalination systems. *Applied Energy*, Vol. 87 (2010) 1122-1133.
- Sommariva, C.; Hogg, H. & Callister, K. (2001). Forty-year design life: the next target material selection and operation conditions in thermal desalination plants. *Desalination*, Vol. 136 (2001) 169-176.
- Sommariva, C. & Syambabu, V. (2001). Increase in water production in UAE. *Desalination*, Vol. 138 (2001)173-179.
- Temstet, C.; Canon, G., Laborie, J. & Durante, A. (1996). A large high-performance MED plant in Sicily. *Desalination*, Vol. 105 (1996) 109-114.
- Utomo, T.; Ji, M.; Kim, P.; Jeong, H. & Chung, H. (2008). CFD analysis of influence of converging duct angle on the steam ejector performance. *Proceeding of the International Conference on Engineering Optimization*, Rio de Janeiro, June 2008, Brazil.
- Wade, N. (2001). Distillation plant development and cost update. *Desalination*, 136 (2001) 3-12.
- Wangnick, K. (2004). Present status of thermal seawater desalination techniques. http://www.idswater.com/Common/Paper/Paper_51/Klaus.pdf.

- Wang, Y. & Lior, N. (2006). Performance analysis of combined humidified gas turbine power generation and multi-effect thermal vapor compression desalination systems – Part 1: The desalination unit and its combination with a steam-injected gas turbine power system. *Desalination*, Vol. 196 (2006) 84-104.



Desalination, Trends and Technologies

Edited by Michael Schorr

ISBN 978-953-307-311-8

Hard cover, 334 pages

Publisher InTech

Published online 28, February, 2011

Published in print edition February, 2011

The book comprises 14 chapters covering all the issues related to water desalination. These chapters emphasize the relationship between problems encountered with the use of feed water, the processes developed to address them, the operation of the required plants and solutions actually implemented. This compendium will assist designers, engineers and investigators to select the process and plant configuration that are most appropriate for the particular feed water to be used, for the geographic region considered, as well as for the characteristics required of the treated water produced. This survey offers a comprehensive, hierarchical and logical assessment of the entire desalination industry. It starts with the worldwide scarcity of water and energy, continues with the thermal - and membrane-based processes and, finally, presents the design and operation of large and small desalination plants. As such, it covers all the scientific, technological and economical aspects of this critical industry, not disregarding its environmental and social points of view. One of InTech's books has received widespread praise across a number of key publications. Desalination, Trends and Technologies (Ed. Schorr, M. 2011) has been reviewed in Corrosion Engineering, Science & Technology – the official magazine for the Institute of Materials, Minerals & Mining, and Taylor & Francis's Desalination Publications. Praised for its “multi-faceted content [which] contributes to enrich it,” and described as “an essential companion...[that] enables the reader to gain a deeper understanding of the desalination industry,” this book is testament to the quality improvements we have been striving towards over the last twelve months.

How to reference

In order to correctly reference this scholarly work, feel free to copy and paste the following:

Anwar Bin Amer (2011). New Trend in the Development of ME-TVC Desalination System, Desalination, Trends and Technologies, Michael Schorr (Ed.), ISBN: 978-953-307-311-8, InTech, Available from: <http://www.intechopen.com/books/desalination-trends-and-technologies/new-trend-in-the-development-of-me-tvc-desalination-system>

INTECH
open science | open minds

InTech Europe

University Campus STeP Ri
Slavka Krautzeka 83/A
51000 Rijeka, Croatia

InTech China

Unit 405, Office Block, Hotel Equatorial Shanghai
No.65, Yan An Road (West), Shanghai, 200040, China
中国上海市延安西路65号上海国际贵都大饭店办公楼405单元

Phone: +385 (51) 770 447
Fax: +385 (51) 686 166
www.intechopen.com

Phone: +86-21-62489820
Fax: +86-21-62489821

© 2011 The Author(s). Licensee IntechOpen. This chapter is distributed under the terms of the [Creative Commons Attribution-NonCommercial-ShareAlike-3.0 License](#), which permits use, distribution and reproduction for non-commercial purposes, provided the original is properly cited and derivative works building on this content are distributed under the same license.